

DAGT

WOOD
MEETS
TECHNOLOGY



FLOORING COLLECTIONS

PARKE KOLEKSİYONLARI



Ahşap teknolojiyle buluşuyor, yaşam alanları yenileniyor!

Doğadan izler taşıyan AGT Parke Serileri, yeniliği yaşam alanlarınıza getirir. Son teknolojiler kullanılarak üretilen parkeler teknik detaylarıyla da fark yaratır.

Farklı zevk ve beklentilere hitap eden geniş ürün skalasıyla her mekana özgün tasarımlar sunar. Zengin doku ve dekor çeşitleri arasından size en uygun olanı seçin, mekanınızda doğayı hissedin!

Yeniliğin öncüsü olan AGT'nin parke serilerini keşfetmeye hazır mısınız?

Wood meets technology, living spaces are being renovated!

AGT Flooring Series, that has traces of nature, brings innovation to your living spaces. All floorings produces with latest technologies of AGT and also make a difference with their technical details. They all offer unique designs to any place with a wide product range that appeal to various tastes and expectations. Choose the one that best suits for you from a variety of rich texture and decor, and feel the nature in your space!

Are you ready to explore AGT's flooring range, a pioneer of innovation?

AGT PARKE TEKNOLOJİK ÖZELLİKLER

AGT FLOORING TECHNOLOGICAL FEATURES



WATER RESISTANT



E0 EMİSYON SEVİYESİ
E0 EMISSION LEVEL



HIZLI VE KOLAY MONTAJ
FAST AND EASY ASSEMBLY



ÇEVRE DOSTU
ENVIRONMENTALLY FRIENDLY



**AŞINMAYA KARŞI
DAYANIKLI**
ABRASION RESISTANT





BLUE ANGEL



YERDEN ISITMAYA UYGUN
*SUITABLE FOR UNDERFLOOR
HEATING*



**KOLAY TEMİZLENİR,
HİJYENİKTİR**
*EASILY CLEANED,
MAINTAINED AND HYGENIC*

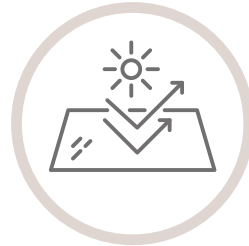

UV İŞINLARINA DAYANIKLI
RESISTANT TO UV RAYS



LEKE TUTMAZ
STAIN RESISTANT



GIDA TEMASINA UYGUN
*SUITABLE FOR FOOD
CONTACT*

NEDEN AGT PARKE? WHY AGT FLOORING?

SÜRDÜRÜLEBİLİR FİKİRLER

AGT, üretimde kullandığı ham maddeyi sürdürülebilir yönetilen ve %100 geri dönüştürülebilir ağaç ve ağaç formlarından elde etmektedir. AGT Biyokütle Enerji Santrali'nde odun atıklarını elektrik enerjisine dönüştürerek sürdürülebilir üretime katkı sağlar.

SUSTAINABLE IDEAS

AGT derives the raw material it uses in its production from sustainable managed and 100% recyclable trees and tree forms. AGT contributes to sustainable production by converting wood waste into electrical energy in its own Biomass Power Plant.



BLUE ANGEL SERTİFİKASI

AGT'nin insan sağlığını koruyan üretimi Blue Angel sertifikası ile tescillenmiştir.

BLUE ANGEL CERTIFICATION

AGT's production that protects human health has been registered with Blue Angel certificate.

KOLAY VE HIZLI KURULUM

AGT Parke Serileri sahip olduđu Click to Fit özelliđi sayesinde hızlı ve kolayca uygulanır. Böylece hem zamandan tasarruf edilir hem de birbirini sıkı tutan yapısı sayesinde sağlam bir uygulama yapılmış olur.

EASY AND FAST INSTALLATION

Thanks to its Click to Fit feature, AGT Flooring Series is quickly and easily applied. In this way, it saves time, and a strong laying is made thanks to its structure which holds it tightly together.



YÜKSEK DAYANIKLILIK

AGT Parke Serileri, yüksek yoğunluklu ağaç liflerinden üretilir ve böylece çok güçlü bir forma ulaşır. Bu teknoloji sayesinde yüksek mukavemet ve çizilmeye karşı direnç sunar ve yıllarca kullanılır.

HIGH DURABILITY

AGT Flooring Series are produced from high density tree fibers and thus reach a very strong form. Thanks to that technology, it offers high strength and scratch resistance, and has been used for years.

MOOD

Yeni/New	Monte	16 - 17
Yeni/New	Murano	18 - 19
Yeni/New	Modena	20 - 21
	Mare	22 - 23
	Marine	24 - 25
	Malta	26 - 27
	Mappa	28 - 29
	Modo	30 - 31
	Marvel	32 - 33
	Teknik Özellikler/ Technical Specifications	34 - 35

MARCO POLO & MARCO POLO PREMIUM

Yeni/New	Novaya	42 - 43
Yeni/New	Hudson	44 - 45
	Kanada	46 - 47
	Florida	48 - 49
	Labrador	50 - 51
	Kaledonya	52 - 53
	Samoa	54 - 55
	Colorado	56 - 57
	Panama	58 - 59
	Teknik Özellikler/ Technical Specifications	60 - 61

YOGA COLLECTION & YOGA COLLECTION PREMIUM

Yeni/New	Astaya	68 - 69
Yeni/New	Sava	70 - 71
	Asana	72 - 73
	Nidra	74 - 75
	Noda	76 - 77
	Yin	78 - 79
	Namaste	80 - 81
	Mantra	82 - 83
	Karma	84 - 85
	Prana	86 - 87
	Teknik Özellikler/ Technical Specifications	88 - 89

EFFECT & EFFECT PREMIUM & EFFECT ELEGANCE

	Alp	96 - 97
	Everest	98 - 99
	Tibet	100 - 101
	Ural	102 - 103
	Solaro	104 - 105
	Logan	106 - 107
	Elbruz	108 - 109
	Nirvana	110 - 111
	Atlas	112 - 113
	Altay	114 - 115
	Pamir	116 - 117
	Fuji	118 - 119
	Rosso	120 - 121
	Toros	122 - 123
	Teknik Özellikler/ Technical Specifications	124 - 125

CONCEPT NEO

	Casella	132 - 133
	Centro	134 - 135
	Dorino	136 - 137
	Scala	138 - 139
	Moderna	140 - 141
	Lima	142 - 143
	Portello	144 - 145
	Pero	146 - 147
	Teknik Özellikler/ Technical Specifications	148 - 149

ARMONIA SLIM/LARGE

	Napoli	156 - 157
	Minori	158 - 159
	Ravello	160 - 161
	Sorento	162 - 163
	Toskana	164 - 165
	Palermo	166 - 167
	Teknik Özellikler/ Technical Specifications	168 - 169

NATURA LINE

Yeni/New	Lena	176 - 177
Yeni/New	Gila	178 - 179
	Nil/Nile	180 - 181
	Volga	182 - 183
	Kanyon Meşe/Canyon Oak	184 - 185
	Tuna	186 - 187
	Salda Meşe/Salda Oak	188 - 189
	Meriç/Meric	190 - 191
	Gala Meşe/Gala Oak	192 - 193
	Ilgaz Meşe/Ilgaz Oak	194 - 195
	Trend Meşe/Trend Oak	196 - 197
	Rodos	198 - 199
	Selge	200 - 201
	Talya	202 - 203
	Teknik Özellikler/ Technical Specifications	204 - 205

PRUVA

	Alesta	212 - 213
	Likya	214 - 215
	Cenova	216 - 217
	Parima	218 - 219
	Patalya	220 - 221
	Teknik Özellikler/ Technical Specifications	222 - 223

LUNA

Yeni/New	Vera	230 - 231
Yeni/New	Kamelya/Camellia	232 - 233
Yeni/New	Lotus	234 - 235
Yeni/New	Yuka/Yucca	236 - 237
	Anemon/Anemone	238 - 239
	Vegas	240 - 241
	Verona	242 - 243
	Akasya/Acacia	244 - 245
	Frezya/Freesia	246 - 247
	Gardenya/Gardenia	248 - 249
	Teknik Özellikler/ Technical Specifications	250 - 251

NATURA SELECT

Yeni/New	Termessos	258 - 259
Yeni/New	Teos	260 - 261
	Sia Meşe/Sia Oak	262 - 263
	Porto	264 - 265
	Patara	266 - 267
	Antalya Çam/Antalya Pine	268 - 269
	Kemer Çam/Kemer Pine	270 - 271
	Kanyon Meşe/Canyon Oak	272 - 273
	Pasifik Çam/Pacific Pine	274 - 275
	Beyaz Meşe/White Oak	276 - 277
	Gri Meşe/Grey Oak	278 - 279
	Silyon Meşe/Silyon Oak	280 - 281
	Şiraz Meşe/Shiraz Oak	282 - 283
	Patricia	284 - 285
	Natura Meşe/Natura Oak	286 - 287
	Olimpos Meşe/Olympus Oak	288 - 289
	Teknik Özellikler/ Technical Specifications	290 - 291

BELLA NEO

Yeni/New	Vera	298 - 299
Yeni/New	Kamelya/Camellia	300 - 301
Yeni/New	Lotus	302 - 303
Yeni/New	Yuka/Yucca	304 - 305
	Verona	306 - 307
	Manolya/Magnolia	308 - 309
	Lilyum/Lilies	310 - 311
	Vegas	312 - 313
	Anemon/Anemone	314 - 315
	Akasya/Acacia	316 - 317
	Frezya/Freesia	318 - 319
	Gardenya/Gardenia	320 - 321
	Defne/Daphne	322 - 323
	Teknik Özellikler/ Technical Specifications	324 - 325

YENİ
KOLEKSİYON
NEW
COLLECTION

CORVINA

Kaleo	332 - 333
Molette	334 - 335
Albana	336 - 337
Faba	338 - 339
Vega	340 - 341
Astera	342 - 343
Anita	344 - 345
Perle	346 - 347
Pigato	348 - 349
Teknik Özellikler/ Technical Specifications	350 - 351

SÜPÜRGELİK PROFİLLERİ SKIRTING PROFILES

356 - 357





10 MM
FLOORING
PARKE

MOOD





Suya Dirençli Mood ile Tanışın!

72 saate kadar su direnci özelliğine sahip AGT Mood Koleksiyonu ile tanışın. Nemli iç mekanlarda kaydırmazlık özelliğine sahip Mood Serisi, ahşap ve taş dekorlarıyla her zevke ve ihtiyaca hitap ediyor.

Meet the Water-resistant Mood!

Meet the AGT Mood Collection, which has water resistance for up to 72 hours. Mood Series, with its non-slip feature in humid interiors, appeals to all tastes and needs with its wood and stone decors.



WATER RESISTANT
ISO 4760



En Width	Boy Length	Kalınlık Thickness	Paket kg Package kg	Paket m ² Package m ²
325 mm	1195 mm	10 mm	~17,50	~1,9418



WATER RESISTANT
ISO 4760



20
YIL GARANTİ



K-Q
TSE-ISO-EN
9000



V



TS EN 13229+A2



L2C



TS EN 12664



TS EN 13501-1



TS EN 16165



TS EN ISO
12460-3



EN 71-10 and
EN 71-11



TS EN
13329+A2



EN 14041:2008



DE-UZ-176

Kalınlık ± 0,30 mm değişiklik gösterebilmektedir.

Thickness can vary by ±0.30 mm.

MOOD DEKORLAR

MOOD DECORS

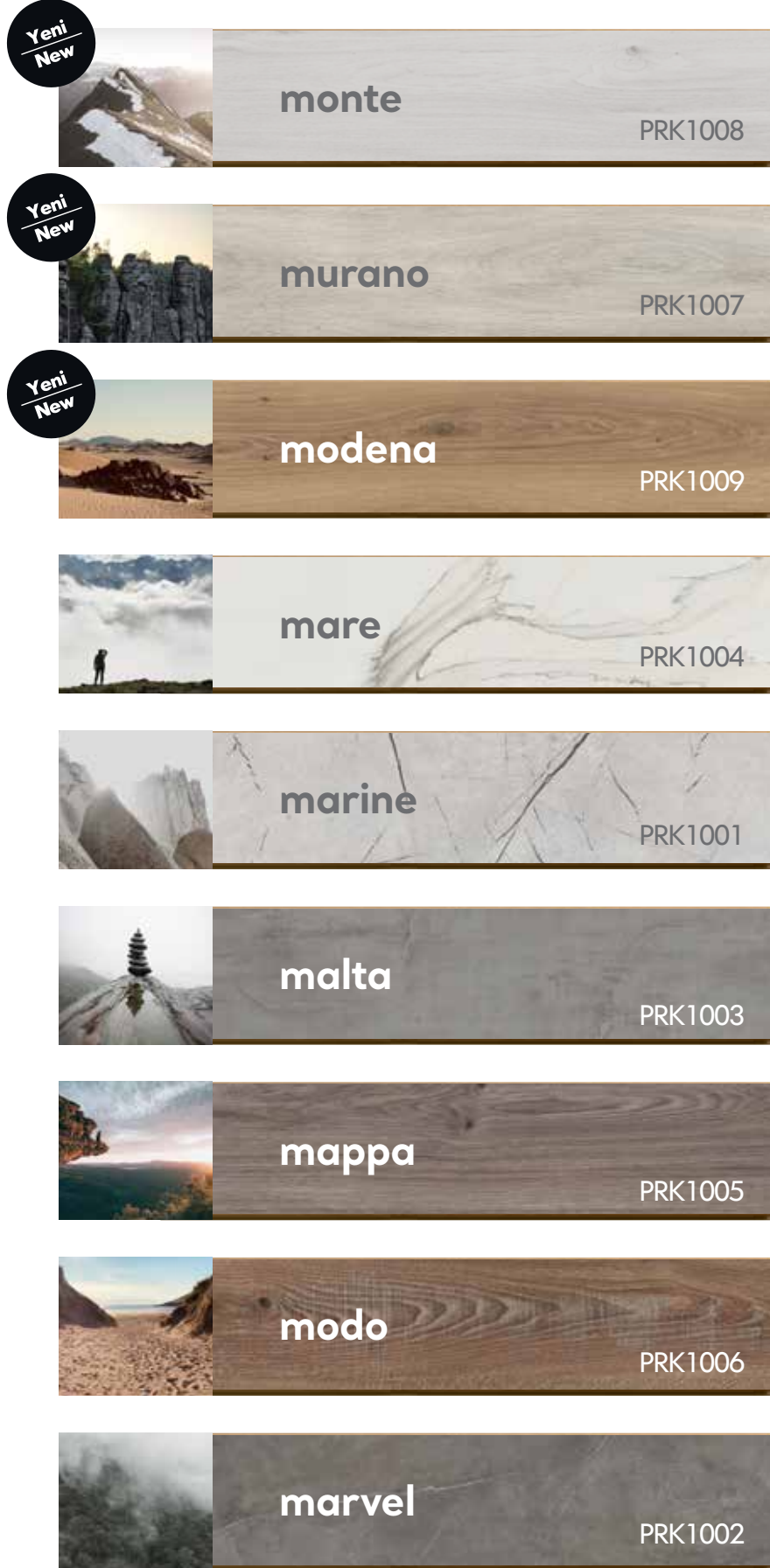

Dekor renkleri ile uyumlu zengin renk alternatiflerine sahip süpürgelik çeşitleri bulunmaktadır.

There are skirting options and rich color alternatives that match the decor colors.

yeni new

monte



Monte'nin zirvesinde yer alın!
Monte'nin zirvelerinden ilham alan bu tasarım, doğanın sakinliğini yaşam alanlarınıza taşıyor. Kayalıkların griliğini kar beyazıyla harmanlayan renk tonları, iç mekanlarınıza huzur ve zarafet katıyor.

*Take your place at the summit of Monte!
Inspired by the peaks of Monte, this design brings the tranquility of nature into your living spaces. The color tones, blending the grey of the rocks with the white of snow, add peace and elegance to your interiors.*



TS EN 13229+A2



TS EN 12664



WATER RESISTANT
ISO 4760



TS EN 13501-1



TS EN 16165



TS EN ISO 12460-3



EN 71-10 and EN 71-11



TS EN 13329+A2



EN 14041:2008



DE-UZ-176

yeni new

murano



Murano Adaları'nın gizemli kayalıklarını keşfe çıkın!
Gün boyu sahili bekleyen kayalıkların muhteşem renkleriyle mekanlarınıza sakinlik ve estetik katın.

*Explore the mysterious cliffs of the Murano Islands!
Add tranquility and aesthetics to your spaces with the stunning colors of the cliffs that guard the coast all day long.*



TS EN 13329+A2



TS EN 12664



WATER RESISTANT
ISO 4760



TS EN 13501-1



TS EN 16165



TS EN ISO 12460-3



EN 71-10 and EN 71-11



TS EN 13329+A2
Standardına göre test edilmiştir. Test edilmiştir.



EN 14041:2008



DE-UZ-176



yeni new

modena



Modena kumsallarına adım atın!
Modena kumsallarının doğal renklerini ve sıcaklığını hissedeceğiniz, zamansız bir serüven sizi bekliyor.

*Step onto the Modena beaches!
A timeless adventure awaits you, where you'll feel the natural colors and warmth of the Modena beaches.*



TS EN 13229+A2



TS EN 12664



WATER RESISTANT
ISO 4760



TS EN 13501-1



TS EN 16165



TS EN ISO 12460-3



EN 71-10 and EN 71-11



TS EN 13329+A2



EN 14041:2008



DE-UZ-176

mare



Mermerin sakinlik veren hissi!
Mare'nin suya dayanikli yapisi ve acik mermer tonunu keşfedin.

*The calming feeling of marble!
Discover the water-resistant structure and light marble tone of Mare.*



TS EN 13229-A2



TS EN 12664



TS EN 13501-1



TS EN 16165



TS EN ISO 12460-3



EN 71-10 and EN 71-11



TS EN 13329-A2



EN 14041:2008



DE-UZ-176



WATER RESISTANT
ISO 4760



marine



Taş suyla hayat buldu!
Dalgaların kaya ile buluşmasından ilham alan Marine dekoru ile evinizde taş desene yer açın.

*Stone came to life with water!
Make room for the stone pattern in your home with the Marine decor inspired by the meeting of the waves with the rock.*



TS EN 13229+A2



TS EN 12664



WATER RESISTANT
ISO 4760



TS EN 13501-1



TS EN 16165



TS EN ISO 12460-3



EN 71-10 and EN 71-11



TS EN 13329+A2



EN 14041:2008



DE-UZ-176



malta



Yaşam alanlarınızda beton görünümü!
Malta'nın beton etkisi sağlayan dekoru ve suya dayanıklı yapısı ile yaşam alanlarınızda yalın bir görünüme kavuşun.

*Concrete look in your living spaces!
Get a plain look in your living spaces with Malta's concrete-effect decor and water-resistant structure.*



TS EN 13229+A2



TS EN 12664



TS EN 13501-1



TS EN 16165



TS EN ISO 12460-3



EN 71-10 and EN 71-11



TS EN 13329+A2



EN 14041:2008



DE-UZ-176



WATER RESISTANT
ISO 4760



mappa



Şık dekorun yol haritası çizildi!
Mappa'nın suya dayanıklı yapısı ve doğadan ilham alan ahşap dekoruyla mekanınıza modern bir hava katın.

*A roadmap of stylish decor has been drawn!
Add a modern flair to your space with Mappa's water-resistant structure and nature-inspired wooden decor.*



TS EN 13329+A2



TS EN 12664



WATER RESISTANT
ISO 4760



TS EN 13501-1



TS EN 16165



TS EN ISO 12460-3



EN 71-10 and EN 71-11



TS EN 13329+A2
Standardına göre test edilmiştir. Test edilmiştir.



EN 14041:2008



DE-UZ-176



modo



Modo ile modunuzu yüksek tutun!
Modo'nun suya dayanıklı yapısı, sıcak ahşap tonları ve rustik görünümü ile mekanınızın havası değişsin.

*Keep your mood up with Modo!
Change the atmosphere of your space with Modo's water-resistant structure, warm wood tones and rustic appearance.*



TS EN 13329+A2



TS EN 12664



WATER RESISTANT
ISO 4760



TS EN 13501-1



TS EN 16165



TS EN ISO 12460-3



EN 71-10 and EN 71-11



TS EN 13329+A2
Standardına göre test edilmiştir. Test edilmiştir.



EN 14041:2008



DE-UZ-176



marvel



Zeminde sıra dışı bir deneyime hazırlanın!
Marvel'in koyu taş tonlarının sağladığı
sofistike görünümün ve suya dayanıklı
yapısının tadını çıkarın.

*Get ready for an extraordinary experience
on the ground!
Enjoy the sophisticated look and water-
resistant construction provided by Marvel's
dark stone tones.*



TS EN 13329+A2



TS EN 12664



WATER RESISTANT
ISO 4760



TS EN 13501-1



TS EN 16165



TS EN ISO 12460-3



EN 71-10 and EN 71-11



TS EN 13329+A2
Standardına göre test edilmiş. Test edilmiştir.



EN 14041:2008



DE-UZ-176

MOOD TEKNİK ÖZELLİKLER MOOD TECHNICAL SPECIFICATIONS

ÖZELLİKLER / SPECIFICATIONS	STANDART / STANDARD	SONUÇLAR / RESULTS
Elementler arası kalınlık farkı <i>Thickness difference between elements</i>	EN 13329	T ortalama < 0,50 mm t max-t min < 0,50 mm <i>T average < 0,50 mm t max-t min < 0,50 mm</i>
Aşınma dayanımı (AC4) <i>Abrasion Resistance (AC4)</i>	EN 13329	Devir > 4000 <i>Cycle > 4000</i>
Aşınma sınıfı <i>Abrasion Class</i>	EN 13329	32. Sınıf <i>32. Class</i>
Elementin baş kısım gönye sapması <i>Deviation from squareness of element</i>	EN 13329	Q max < 0,2mm
Yüzey tabakasının uzunluğu <i>Length tolerance</i>	EN 13329	l < 1500mm l fark < 0,5mm <i>l < 1500mm l difference < 0,5mm</i>
Yüzey tabakasının genişliği <i>Width tolerance</i>	EN 13329	W ortalama fark 0,10mm w max- w min < 0,20mm <i>W average difference 0,10mm w max- w min < 0,20mm</i>
Kılıcına dönme miktarı <i>Edgewise bending</i>	EN 13329	0,30 mm
Elementin yüzey düzgünlüğü <i>Element's surface smoothness</i>	EN 13329	Fw içbükey < %0,15 fw dışbükey < %0,20 F1 içbükey < %0,50 fl dışbükey < %1,00 <i>Fw concave < %0,15 fw convex < %0,20 F1 concave < %0,50 fl convex < %1,00</i>
Elementler arası açıklık <i>Space between elements</i>	EN 13329	O ortalama < 0,15mm o max 0,15mm <i>O avergae < 0,15mm o max 0,15mm</i>
Elementler arası yükseklik farkı <i>Height difference between elements</i>	EN 13329	H ortalama < 0,10mm H max < 0,15mm <i>H avergae < 0,10mm H max < 0,15mm</i>
Yüzey sağlamlığı <i>Surface soundness</i>	EN 13329	AC4 ≥ 1,25 N/mm ²
Işık haslığı <i>Light fastness</i>	EN ISO 4892 - 2:200	EN 20105 - A02'ye göre gri ölçekte ≥ 4 maruz kalmayan ve maruz kalan örnek parça arasındaki renk kontrastı <i>Colour contrast between unexposed and exposed sample part ≥ 4 of grey scale according to EN 20105 - A02</i>
Çarpma mukavemeti <i>Impact resistance</i>	EN 13329	32. sınıf için IC2 <i>IC2 for 32th class</i>
Koltuk tekerleği etkisi <i>Determination of the effect of a castor chair</i>	EN 425	Görünümde bir değişiklik veya zarar olmayacak <i>No change or damage on appearance should occur</i>
Çizilme mukavemeti (N) <i>Scratch resistance (N)</i>	EN438-2	≥ 3,5 N

ÖZELLİKLER / SPECIFICATIONS	STANDART / STANDARD	SONUÇLAR / RESULTS
Mobilya ayağı etkisi <i>Determination of the effect of a castor furniture</i>	EN 424	Görülebilir zarar olmamalıdır. <i>No visible damage should occur</i>
Sıcak kaplara dayanıklılık <i>Resistance to hot pots</i>	EN 438-2	Sınıf 4 / Class 4
Su buharına karşı dayanıklılık <i>Resistance to water vapor</i>	EN 438-2	Sınıf 4 / Class 4
Leke tutmaya karşı dayanıklılık <i>Stain resistance</i>	EN 438-2	Sınıf 5 / Class 5
24 saat suda şişme <i>24 hours swelling in thickness</i>	EN 13329	<%18
Yoğunluk <i>Density</i>	EN 323	AGT'ye özgü / Specific to AGT
Eğilme dayanımı <i>Bending strenght</i>	EN 317	40 N/mm ²
Elastikiyet modülü <i>Modulus of elasticity</i>	EN 310	3500 N/mm ²
Çekme dayanımı <i>Vertical internal bond</i>	EN 319	≥1,20 N/mm ²

AŞINMA SINIFLARI/ABRASION CLASSES

MOOD	Az / Low			Yoğun / High		
	21	22	23	31	32	33
	AC1	AC2	AC3		AC4	AC5
Ortalama aşınma değeri / Average abrasion value	> 900	>1500	>2000		>4000	>6000

Renkler basılı ve dijital kataloglarda farklılık gösterebilir. Lütfen, satış noktalarımızda bulunan gerçek ürünler ile karşılaştırınız.

Colors may vary in digital and printed catalogs. Please compare with the actual products in the sales points.



8-12 MM
FLOORING
PARKE

MARCO
POLO





Bir Keşfin Hikayesi

Marco Polo'nun serüveninden ilhamla oluşturduğumuz;
büyük liman şehirlerinden ismini alan, muhteşem
ahşap yüzeyi, koyu ve açık renk geçişleriyle mekanlarınızda
güçlü kontrast etkisi yaratacak,
bambaşka bir tasarım macerasına yelken açıyoruz.

A Story of Discovery

*Inspired by the adventure of Marco Polo; we are sailing on a
completely different design adventure, named after
the big port cities, that will create a strong contrast effect in
your spaces with its magnificent wooden surface,
dark and light color transitions.*



	En Width	Boy Length	Kalınlık Thickness	Paket kg Package kg	Paket m ² Package m ²	Garanti Süresi Warranty	Aşınma Sınıfı Abrasion Class
Marco Polo	191 mm	1200 mm	8 mm	~13,20	~1,8336	20	
Marco Polo Premium UNIFIT PATENTED TECHNOLOGY	189 mm	1195 mm	12 mm	~14,60	~1,3551	25	

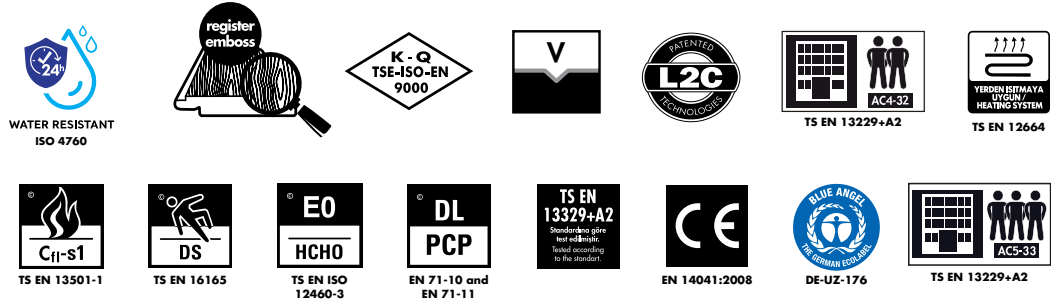

Kalınlık ± 0,30 mm değişiklik gösterebilmektedir.

Thickness can vary by ±0.30 mm.

MARCO POLO DEKORLAR

MARCO POLO DECORS

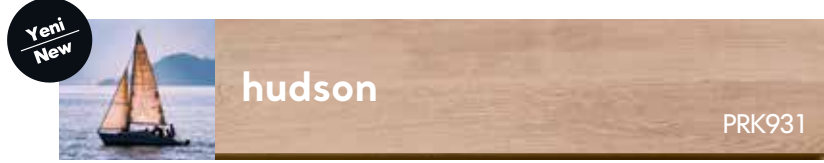

Dekor renkleri ile uyumlu zengin renk alternatiflerine sahip süpürgelik çeşitleri bulunmaktadır.

There are skirting options and rich color alternatives that match the decor colors.

yeni new

novaya



Novaya Takım Adaları'nın doğallığı ile tanışın!

Nefes kesici mercan resiflerinden ve mistik ormanlardan gelen yepyeni bir esinti sizi bekliyor. Rotanızı bu göz alıcı tasarıma çevirmeye ve mekanlarınızın havasını değiştirmeye hazır mısınız?

Get to know the natural vibes of the Novaya Team Islands!

A fresh breeze from the stunning coral reefs and mystical forests is waiting for you. Ready to switch up your vibe with this eye-catching design and transform the feel of your spaces?





yeni new

hudson



Mükemmelliği Hudson'da keşfedin!
Hudson Körfezi'nin sakinliğinden ve doğal güzelliklerinden ilham alındı. Aynı mükemmellikte mekanlara adım atmanız için tasarlandı.

*Discover perfection in Hudson!
Inspired by the calm and natural beauty of Hudson Bay, it's designed for you to step into spaces of the same excellence.*



kanada



Beyazlar şehri Kanada!
Güçlü iklimi ve etkileyici doğasından ilhamla tasarlanan beyazlar içindeki özgün dokunuşu hisset.

*Canada, the city of whites!
Feel the original touch in whites designed with inspiration from the cold climate.*





florida



Florida sahillerinin esintisi!
Florida sahillerinin gri-beyaz toprak tonlarından esinlenerek üretilmiş parkemiz ile sahil havasını evinizde hissedin.

*The breeze of Florida beaches!
Feel the beach air at home with our flooring inspired by the gray-white earth tones of Florida beaches.*

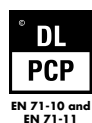



labrador



Mekanına farklı bir boyut kat!
Renklerin doğayla iç içe geçtiği, içinizi ısıtacak dekoru evlerinize çağırın.

*Add a new dimension to your space!
Call on decor that blends colors with nature and warms you to the core for your homes.*

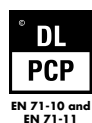

kaledonya





Adım adım Kaledonya!
Kaledonya adasının sıcak toprak tonunu
adımlarınızda hissedin.

*Caledonia step by step!
Feel the warm earth tone of the island of
Caledonia in your steps.*





samoa



Samoa Adaları'nın manzarası...
Samoa Adaları'nın sislerinin gölgesindeki manzarayı evlerinize taşıyın.

*The view of the Samoan Islands...
Bring the scenery under the shadow of the mists of Samoan Islands to your homes.*





colorado



Colorado isminden ilhamla!
İsminden ilham alınarak tasarlanan, renkli toprakları çağrıştıran büyüleyici tonuyla Colorado ile tanışın.

*Inspired by the name Colorado!
Meet Colorado with its enchanting tone,
inspired by its name, evoking colorful lands.*

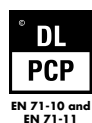



panama

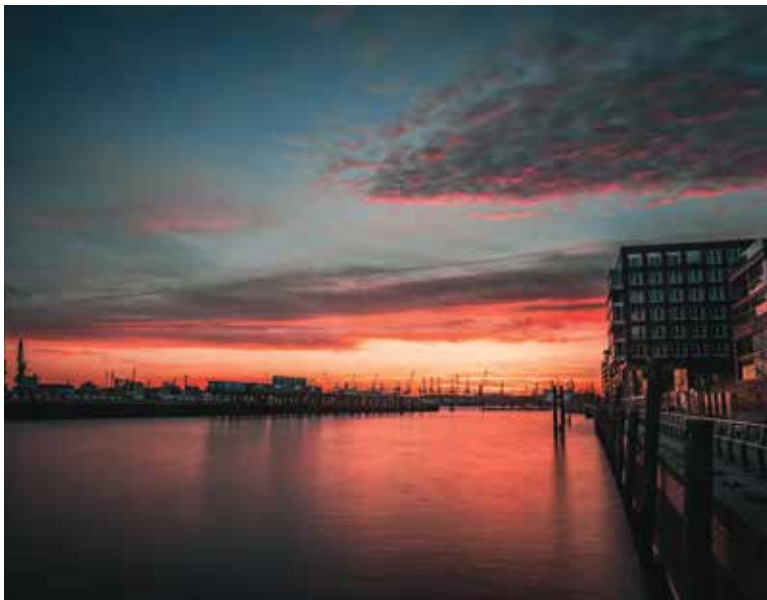

Panama sahillerinin enerjisi!
Panama sahillerinin ışıltılı enerjisini yaşam alanlarınıza taşıyın.

*The energy of the Panama beaches!
Bring the sparkling energy of Panama beaches to your living spaces.*

WATER RESISTANT ISO 4760
register emboss
K-Q TSE-ISO-EN 9000
V
L2C
TS EN 13229+A2
TS EN 12664
Cfl-s1
DS
E0 HCHO
DL PCP
TS EN 13329+A2
CE
DE-UZ-176
TS EN 13229+A2

MARCO POLO/MARCO POLO PREMIUM TEKNİK ÖZELLİKLER

MARCO POLO/MARCO POLO PREMIUM TECHNICAL SPECIFICATIONS

ÖZELLİKLER / SPECIFICATIONS	STANDART / STANDARD	SONUÇLAR / RESULTS
Elementler arası kalınlık farkı <i>Thickness difference between elements</i>	EN 13329	T ortalama< 0,50 mm t max-t min<0,50 mm <i>T average< 0,50 mm t max-t min<0,50 mm</i>
Aşınma dayanımı <i>Abrasion Resistance</i>	EN 438	Marco Polo: Devir>4000 Cycle>4000 Marco Polo Premium: Devir>6000 Cycle>6000
Elementin baş kısım gönye sapması <i>Deviation from squareness of element</i>	EN 13329	Q max< 0,2mm
Yüzey tabakasının uzunluğu <i>Length tolerance</i>	EN 13329	l<1500mm l fark<0,5mm <i>l<1500mm l difference<0,5mm</i>
Yüzey tabakasının genişliği <i>Width tolerance</i>	EN 13329	W ortalama fark 0,10mm w max- w min<0,20mm <i>W average difference 0,10mm w max- w min<0,20mm</i>
Kılıcına dönme miktarı <i>Edgewise bending</i>	EN 13329	0,30 mm
Elementin yüzey düzgünlüğü <i>Element's surface smoothness</i>	EN 13329	Fw içbükey <%0,15 fw dışbükey <%0,20 F1 içbükey <%0,50 fl dışbükey <%1,00 <i>Fw concave <%0,15 fw convex <%0,20 F1 concave <%0,50 fl convex <%1,00</i>
Elementler arası açıklık <i>Space between elements</i>	EN 13329	O ortalama<0,15mm o max 0,15mm <i>O average<0,15mm o max 0,15mm</i>
Elementler arası yükseklik farkı <i>Height difference between elements</i>	EN 13329	H ortalama< 0,10mm H max<0,15mm <i>H average< 0,10mm H max<0,15mm</i>
Yüzey sağlamlığı <i>Surface soundness</i>	EN 13329	AC4 / AC5 ≥1,25 N/mm ²
Çizilme mukavemeti (N) <i>Scratch resistance</i>	EN 438	>3,5
Işık haslığı <i>Light fastness</i>	EN ISO 4892 - 2:200	EN 20105 - A02'ye göre gri ölçekte ≥4 maruz kalmayan ve maruz kalan örnek parça arasındaki renk kontrastı <i>Colour contrast between unexposed and exposed sample part ≥ 4 of grey scale according to EN 20105 - A02</i>
Çarpma mukavemeti <i>Impact resistance</i>	EN 13329	32. sınıf için IC2 / IC2 for 32th class 33. sınıf için IC3 / IC3 for 33th class
Koltuk tekerleği etkisi <i>Determination of the effect of a castor chair</i>	EN 425	Görünümde bir değişiklik veya zarar olmayacak <i>No change or damage on appearance should occur</i>
Mobilya ayağı etkisi <i>Determination of the effect of a castor furniture</i>	EN 424	Görülebilir zarar olmamalıdır. <i>No visible damage should occur</i>
Sıcak kaplara dayanıklılık <i>Resistance to hot pots</i>	EN 13329	Sınıf 4 / Class 4
Su buharına karşı dayanıklılık <i>Resistance to water vapor</i>	EN 13329	Sınıf 4 / Class 4
Leke tutmaya karşı dayanıklılık <i>Stain resistance</i>	EN 13329	Sınıf 5 / Class 5
24 saat suda şişme <i>24 hours swelling in thickness</i>	EN 13329	<%18
Yoğunluk <i>Density</i>	EN 323	AGT'ye özgü/Specific to AGT
Eğilme dayanımı <i>Bending strenght</i>	EN 317	40 N/mm ²
Elastikiyet modülü <i>Modulus of elasticity</i>	EN 310	3500 N/mm ²
Çekme dayanımı <i>Vertical internal bond</i>	EN 319	≥1,2 N/mm ²

AŞINMA SINIFLARI/ABRASION CLASSES

	Az / low				Yoğun / High	
MARCO POLO	21	22	23	31	32	33
	AC1	AC2	AC3		AC4	AC5
Ortalama aşınma değeri / Average abrasion value	> 900	>1500	>2000		>4000	>6000

AŞINMA SINIFLARI/ABRASION CLASSES

	Az / low				Yoğun / High	
MARCO POLO PREMIUM	21	22	23	31	32	33
	AC1	AC2	AC3		AC4	AC5
Ortalama aşınma değeri / Average abrasion value	> 900	>1500	>2000		>4000	>6000



8-12 MM
FLOORING
PARKE

YOGA
COLLECTION





AGT Yoga Serisi ile Nefes Alan Mekanlar Yaratın!

Huzur ve dinginlik arıyorsanız, çevrenizi AGT Yoga Serisi ile donatın. Üstün antistatik özelliği sayesinde vücudunuzda statik elektrik yüklenmesini azaltır. Hem tasarımı hem de teknolojisi ile içinizdeki dengeyi sağlamanıza yardımcı olur.

Create Breathing Spaces with AGT Yoga Series!

If you're seeking peace and tranquility, equip your surroundings with the AGT Yoga Series.

Its superior anti-static feature reduces static electricity build-up on your body. With its design and technology, it helps you achieve inner balance.



	En Width	Boy Length	Kalınlık Thickness	Paket kg Package kg	Paket m ² Package m ²	Garanti Süresi Warranty	Aşınma Sınıfı Abrasion Class
Yoga Collection	191 mm	1200 mm	8 mm	~13,20	~1,8336	20	AC4-32
Yoga Collection Premium	189 mm	1195 mm	12 mm	~14,60	~1,3551	25	AC5-33

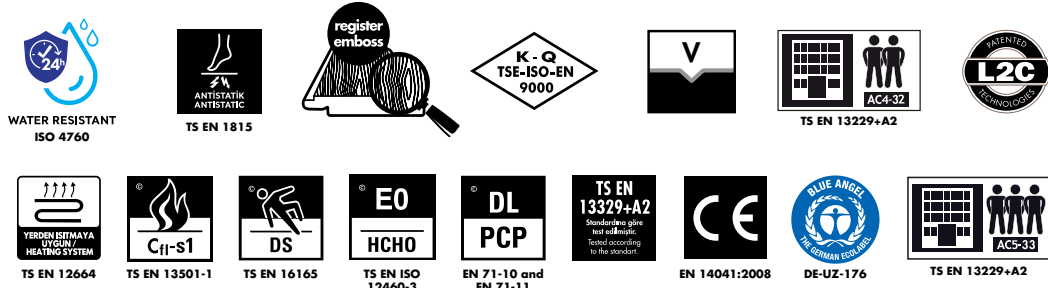











Kalınlık ± 0,30 mm değişiklik gösterebilmektedir.

Thickness can vary by ±0.30 mm.

YOGA COLLECTION DEKORLAR

YOGA COLLECTION DECORS

	astaya	PRK933
	sava	PRK934
	asana	PRK923
	nidra	PRK929
	noda	PRK925
	yin	PRK930
	namaste	PRK924
	mantra	PRK927
	karma	PRK926
	prana	PRK928

Dekor renkleri ile uyumlu zengin renk alternatiflerine sahip süpürgelik çeşitleri bulunmaktadır.

There are skirting options and rich color alternatives that match the decor colors.

yeni new

astaya

Yoga

COLLECTION



Astaya felsefesiyle hep dengede kalın!
Doğal taşlara atacağınız her adımda ve her nefeste gri ve beyaz renklerin mükemmel uyumunu, sakinliğini ve huzurunu hissedin.

*Stay balanced with the philosophy of Astaya!
With every step you take on natural stones and every breath, feel the perfect harmony, calmness, and peace of grey and white colors.*



yeni new

saiva

Yoga

COLLECTION

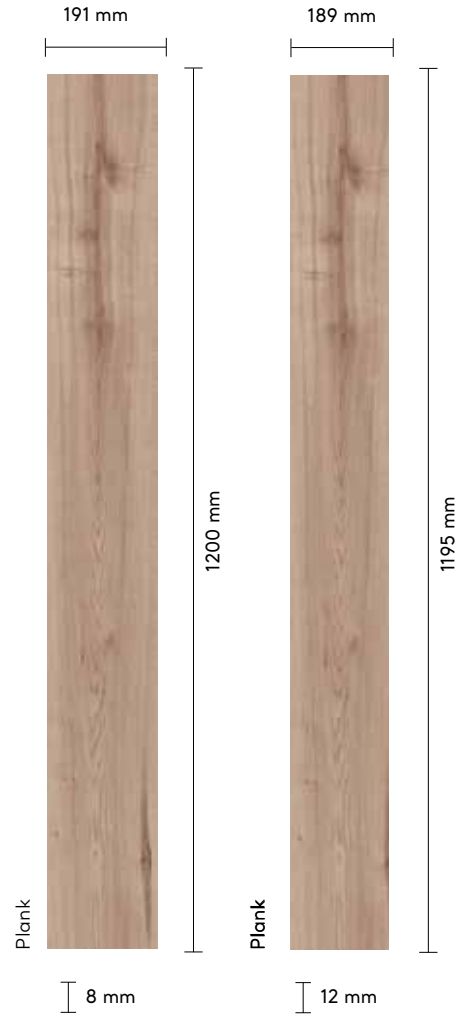

Sava Bölgesi: Sakinliğin ta kendisi!
Sava'dan ilham alan bu seriyle mekanlarınıza eşsiz bir dokunuş yapın, sakinlik ve zarafetin keyfini çıkarın.

*The Sava Region: The essence of tranquility itself!
Add a unique touch to your spaces with this series inspired by Sava, and enjoy the luxury of calmness and elegance.*



WATER RESISTANT
ISO 4760



TS EN 1815



TS EN 13329+A2



TS EN 12664



TS EN 13501-1



TS EN 16165



TS EN ISO
12460-3



EN 71-10 and
EN 71-11



TS EN
13329+A2



EN 14041:2008



DE-UZ-176



TS EN 13329+A2

asana



Yoga

COLLECTION



Sürdürülebilir kaynaklarla üretilen Asana, kullanıcıların favorisi. Özel dokulu parke seçenekleri, darbeler ve aşınmaya karşı dayanıklılık sağlar. Modern ve estetik bir görünüme sahip olan Asana, uzun ömürlü kullanım sunar.

Asana, produced with sustainable resources, is a user favorite. Specially textured parquet options provide resistance to impacts and abrasion. With its modern and aesthetic appearance, Asana ensures long-lasting use.



WATER RESISTANT
ISO 4760



ANTİSTATİK
ANTISTATIC
TS EN 1815



TS EN 13229+A2



YERDEN ISINMAYA
UYGUN
HEATING SYSTEM
TS EN 12664



Cfl-s1
TS EN 13501-1



DS
TS EN 16165



EO
HCHO
TS EN ISO
12460-3



DL
PCP
EN 71-10 and
EN 71-11



TS EN
13329+A2
Standardına göre
test edilmiştir.
Tested according
to the standard



EN 14041:2008



DE-UZ-176



TS EN 13229+A2



nidra

Yoga

COLLECTION



Stresi geride bırakmak ve anı yaşamak için adım atın.
Nidra'nın antistatik özelliği sayesinde evinizde bile çıplak ayakla toprağa basma deneyimi yaşayın, doğanın huzurunu evinizde hissedin.

*Take steps to leave stress behind and live in the moment.
With Nidra's antistatic feature, experience the sensation of walking barefoot on the ground even at home, and feel the peace of nature in your own home.*

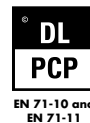



noda

Yoga

COLLECTION



İçinizdeki dengeye ilham verecek, doğal ahşaptan bir tasarım.
Açık ve koyu arasında denge oluşturan nötr tonuyla mekana enerji katın.
Doğal damarlı özel doku detayıyla sessizliği ve dinginliği ortama yansıtın.

*A design crafted from natural wood that will inspire balance within you.
Add energy to the space with its neutral tone, creating harmony between light and dark.
Reflect tranquility and serenity in the environment with its unique natural grain.*





yin

Yoga

COLLECTION



Doğanın huzurunu evinize getiren renklerle, dişil enerjinizi aktifleştirin. Antistatik özelliği sayesinde, toprağa çıplak ayakla basmış gibi zinde kalın.

Activate your feminine energy with colors that bring the peace of nature to your home.

Thanks to its antistatic feature, you can feel refreshed as if you were walking barefoot on the ground.



namaste



Yoga

COLLECTION



Doğaya dönüş isteğiniz, minimalizmle buluşsun.
Yaşam alanlarınıza sakinleştiren ve bilgelik dolu bir dokunuş katın.
Sofistike ortamlar yaratmak için Namaste'nin büyüleyici etkisinden ilham alın.

*Let your desire to return to nature meet minimalism.
Add a touch of calm and wisdom to your living spaces.
Let Namaste's enchanting aura inspire the creation of sophisticated environments.*



mantra



Yoga

COLLECTION

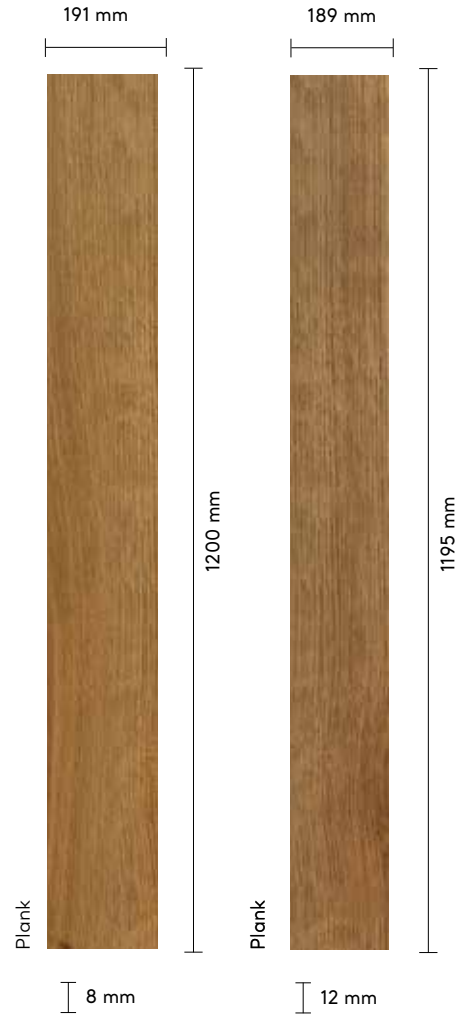

Özgün bir tasarımla, özgür bir ambiyans yaratın. Doğal ahşabı teknolojiyle şekillendiren tasarımların, çarpıcı renk kontrastları ile yaratıcılığınızı ortaya çıkarın.

Create a liberating ambiance with an original design. Unleash your creativity with designs that shape natural wood with technology, highlighting your creativity with striking color contrasts.



WATER RESISTANT
ISO 4760



TS EN 1815



TS EN 13329+A2



TS EN 12664



TS EN 13501-1



TS EN 16165



TS EN ISO
12460-3



EN 71-10 and
EN 71-11



TS EN 13329+A2



EN 14041:2008



DE-UZ-176



TS EN 13329+A2



karma

Yoga

COLLECTION

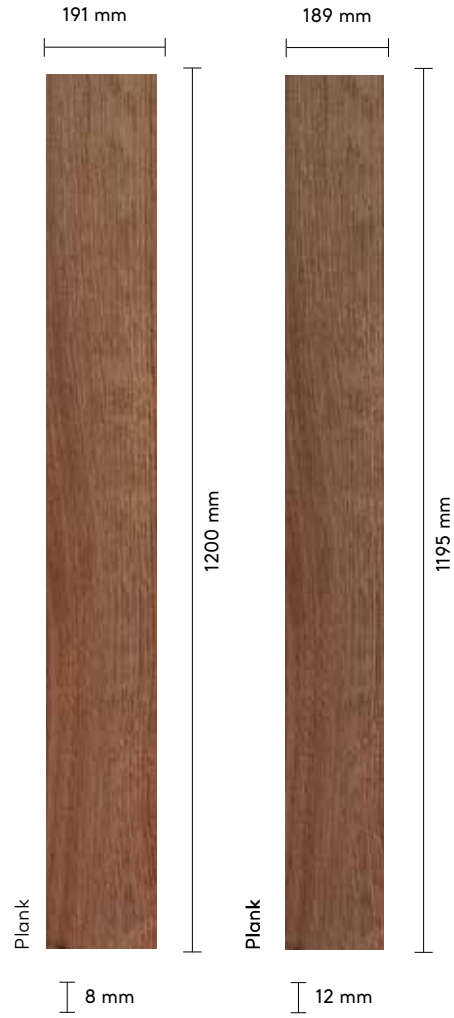

İyiliğin dekora dönüşümü!
Bütün pozitif enerjileri
yaşam alanınıza çekin.

*Transformation of goodness into decor!
Attract all positive energies into
your living space.*



WATER RESISTANT
ISO 4760



TS EN 1815



TS EN 13229+A2



TS EN 12664



TS EN 13501-1



TS EN 16165



TS EN ISO
12460-3



EN 71-10 and
EN 71-11



TS EN 13329+A2



EN 14041:2008



DE-UZ-176



TS EN 13229+A2



prana

Yoga

COLLECTION



Hayat enerjinizin yaşam alanınızdaki hali!
Canlılığı ve ruhunuzdaki enerjiyi
yaşam alanınıza yansıtın.

*The state of your life energy in
your living space!
Reflect the vitality and the
energy in your soul into your living space.*

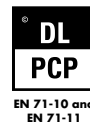

YOGA COLLECTION/YOGA COLLECTION PREMIUM TEKNİK ÖZELLİKLER

YOGA COLLECTION/YOGA COLLECTION PREMIUM TECHNICAL SPECIFICATIONS

ÖZELLİKLER / SPECIFICATIONS	STANDART / STANDARD	SONUÇLAR / RESULTS
Elementler arası kalınlık farkı <i>Thickness difference between elements</i>	EN 13329	T ortalama< 0,50 mm t max-t min<0,50 mm <i>T average< 0,50 mm t max-t min<0,50 mm</i>
Aşınma dayanımı <i>Abrasion Resistance</i>	EN 438	Yoga Collection: Devir>4000 Cycle>4000 Yoga Collection Premium: Devir>6000 Cycle>6000
Elementin baş kısım gönye sapması <i>Deviation from squareness of element</i>	EN 13329	Q max< 0,2mm
Yüzey tabakasının uzunluğu <i>Length tolerance</i>	EN 13329	l<1500mm l fark<0,5mm <i>l<1500mm l difference<0,5mm</i>
Yüzey tabakasının genişliği <i>Width tolerance</i>	EN 13329	W ortalama fark 0,10mm w max- w min<0,20mm <i>W average difference 0,10mm w max- w min<0,20mm</i>
Kılıcına dönme miktarı <i>Edgewise bending</i>	EN 13329	0,30 mm
Elementin yüzey düzgünlüğü <i>Element's surface smoothness</i>	EN 13329	Fw içbükey <%0,15 fw dışbükey <%0,20 F1 içbükey <%0,50 fl dışbükey <%1,00 <i>Fw concave <%0,15 fw convex <%0,20 F1 concave <%0,50 fl convex <%1,00</i>
Elementler arası açıklık <i>Space between elements</i>	EN 13329	O ortalama<0,15mm o max 0,15mm <i>O average<0,15mm o max 0,15mm</i>
Elementler arası yükseklik farkı <i>Height difference between elements</i>	EN 13329	H ortalama< 0,10mm H max<0,15mm <i>H average< 0,10mm H max<0,15mm</i>
Yüzey sağlamlığı <i>Surface soundness</i>	EN 13329	AC4 / AC5 ≥1,25 N/mm ²
Çizilme mukavemeti (N) <i>Scratch resistance</i>	EN 438	>3,5
Işık haslığı <i>Light fastness</i>	EN ISO 4892 - 2:200	EN 20105 - A02'ye göre gri ölçekte ≥4 maruz kalmayan ve maruz kalan örnek parça arasındaki renk kontrastı <i>Colour contrast between unexposed and exposed sample part ≥ 4 of grey scale according to EN 20105 - A02</i>
Çarpma mukavemeti <i>Impact resistance</i>	EN 13329	32. sınıf için IC2 / IC2 for 32th class 33. sınıf için IC3 / IC3 for 33th class
Koltuk tekerleği etkisi <i>Determination of the effect of a castor chair</i>	EN 425	Görünümde bir değişiklik veya zarar olmayacak <i>No change or damage on appearance should occur</i>
Mobilya ayağı etkisi <i>Determination of the effect of a castor furniture</i>	EN 424	Görülebilir zarar olmamalıdır. <i>No visible damage should occur</i>
Sıcak kaplara dayanıklılık <i>Resistance to hot pots</i>	EN 13329	Sınıf 4 / Class 4
Su buharına karşı dayanıklılık <i>Resistance to water vapor</i>	EN 13329	Sınıf 4 / Class 4
Leke tutmaya karşı dayanıklılık <i>Stain resistance</i>	EN 13329	Sınıf 5 / Class 5
24 saat suda şişme <i>24 hours swelling in thickness</i>	EN 13329	<%18
Yoğunluk <i>Density</i>	EN 323	AGT'ye özgü/Specific to AGT
Eğilme dayanımı <i>Bending strenght</i>	EN 317	40 N/mm ²
Elastikiyet modülü <i>Modulus of elasticity</i>	EN 310	3500 N/mm ²
Çekme dayanımı <i>Vertical internal bond</i>	EN 319	≥1,2 N/mm ²

AŞINMA SINIFLARI/ABRASION CLASSES

Az / Low

Yoğun / High

YOGA COLLECTION

21

22

23

31

32

33

AC1

AC2

AC3

AC4

AC5

Ortalama aşınma değeri / Average abrasion value

> 900

>1500

>2000

>4000

>6000

AŞINMA SINIFLARI/ABRASION CLASSES

Az / Low

Yoğun / High

YOGA COLLECTION PREMIUM

21

22

23

31

32

33

AC1

AC2

AC3

AC4

AC5

Ortalama aşınma değeri / Average abrasion value

> 900

>1500

>2000

>4000

>6000



8-12 MM
FLOORING
PARKE

EFFECT





Doğadan ilham alan Effect, Effect Premium ve Effect Elegance Parke Serileri ile yeniliği keşfedin. Farklı ölçü ve tonlardan dilediğinizi seçin, doğayı yaşam alanlarınızda hissedin!

Experience innovation with the nature-inspired Effect, Effect Premium and Effect Elegance Flooring Series. Choose the best for you from different size and tones, and feel the nature at your living spaces!



	En Width	Boy Length	Kalınlık Thickness	Paket kg Package kg	Paket m ² Package m ²	Garanti Süresi Warranty	Aşınma Sınıfı Abrasion Class
Effect	191 mm	1200 mm	8 mm	~13,20	~1,8336	20	AC32
Effect Premium	189 mm	1195 mm	12 mm	~14,60	~1,3551	25	AC33
Effect Elegance	154,5 mm	1195 mm	12 mm	~12,00	~1,1078	25	AC33

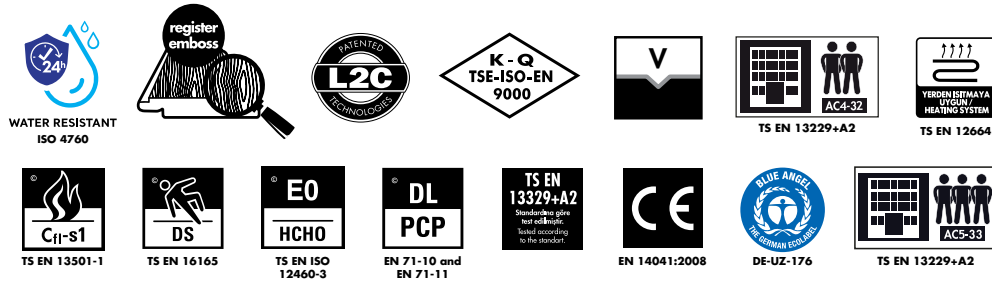

Kalınlık $\pm 0,30$ mm değişiklik gösterebilmektedir.

Thickness can vary by ± 0.30 mm.

EFFECT DEKORLAR

EFFECT DECORS

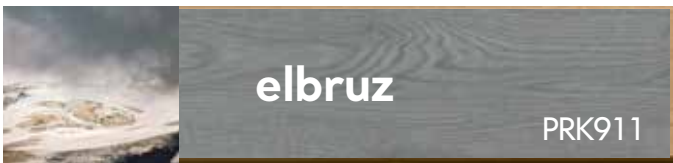
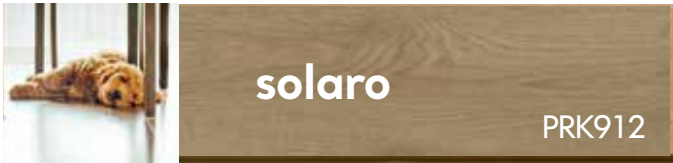
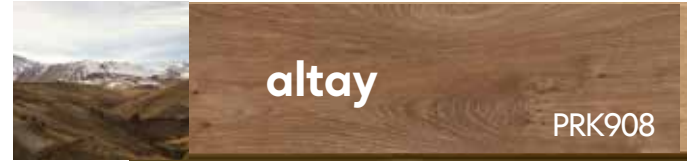
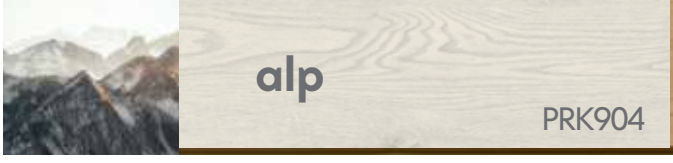

Dekor renkleri ile uyumlu zengin renk alternatiflerine sahip süpürgelik çeşitleri bulunmaktadır.

There are skirting options and rich color alternatives that match the decor colors.



alp

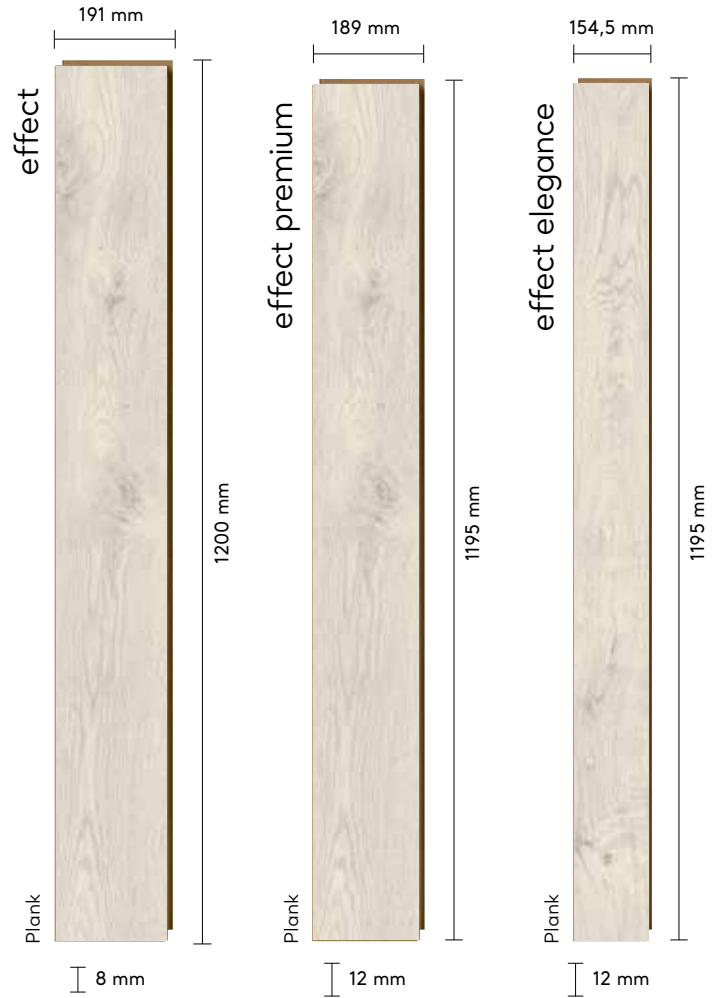

Dağların, kar ve bulutların büyüleyici atmosferi! Mekanınızda ferah bir izlenime sahip olun.

Fascinating atmosphere of mountains, snow and clouds! Have a spacious impression in your space.





everest

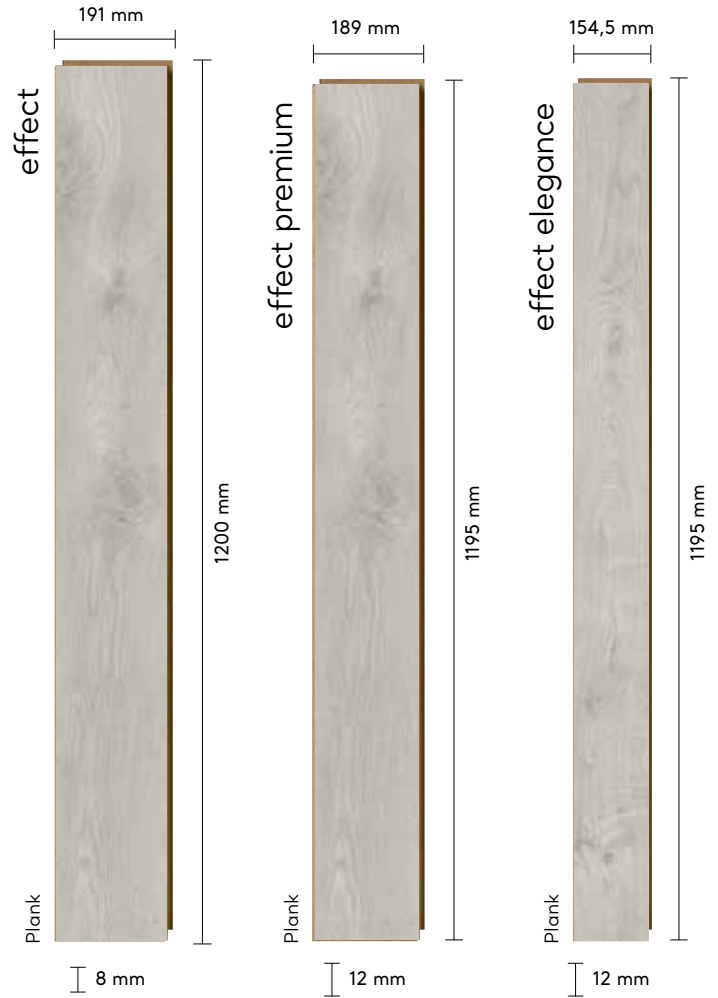

Zirvelerin doğallığı ayaklarınıza serilsin!
Hayal ettiğiniz yeniliğe mekanınızda ulaşın.

Let the naturalness of the peaks lay under your feet! Achieve the innovation you dream of in your space.





tibet



Yaşam alanlarında mistik bir atmosfer!
Tutkuyla şekillenen dekoruyla
doğayı ayaklarınızın altına serin.

*A mystical atmosphere at living spaces.
Lay the nature under your feet
with its passionately shaped decor.*





ural



Toprak tonların sıcaklığı estetikle buluştu!
Her anınızda doğaya bir adım atın.

*The warmth of soil tones met with aesthetics!
Take a step into the nature in every moment.*





solaro

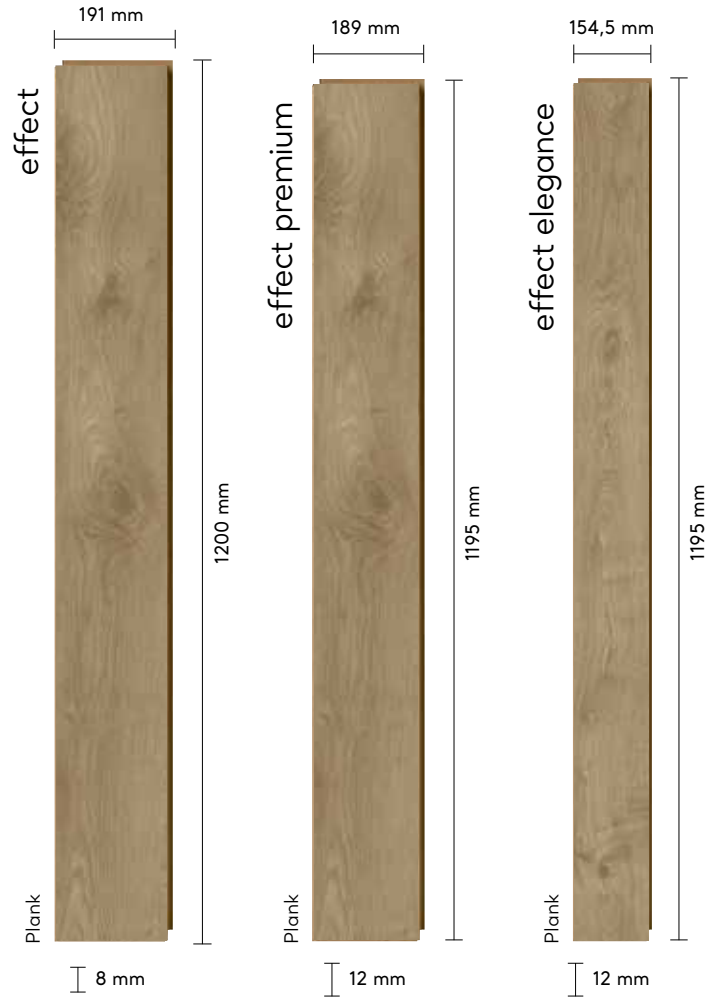

Yaşam alanlarına estetik dokunuşlar!
Her adımınızda Akdeniz'in sıcak tonlarını hissedin.

*Aesthetic touches to living spaces!
Feel the warm tones of the
Mediterranean in your any step.*





logan



Beyaz bulutlar, gri toprak tonlarıyla buluşuyor!
Yaşam alanlarınızda ferahlığı keşfedin.

*Snow white clouds meet grey earth tones!
Discover the freshness in your living spaces.*





elbruz



Buzul kaplı zirvelere doğru bir yolculuk! Karla kaplı dağların güzelliğini mekanınıza taşıyın.

*A journey to the glacial peaks!
Bring the magical beauty of the snow-covered mountains to your place.*





nirvana

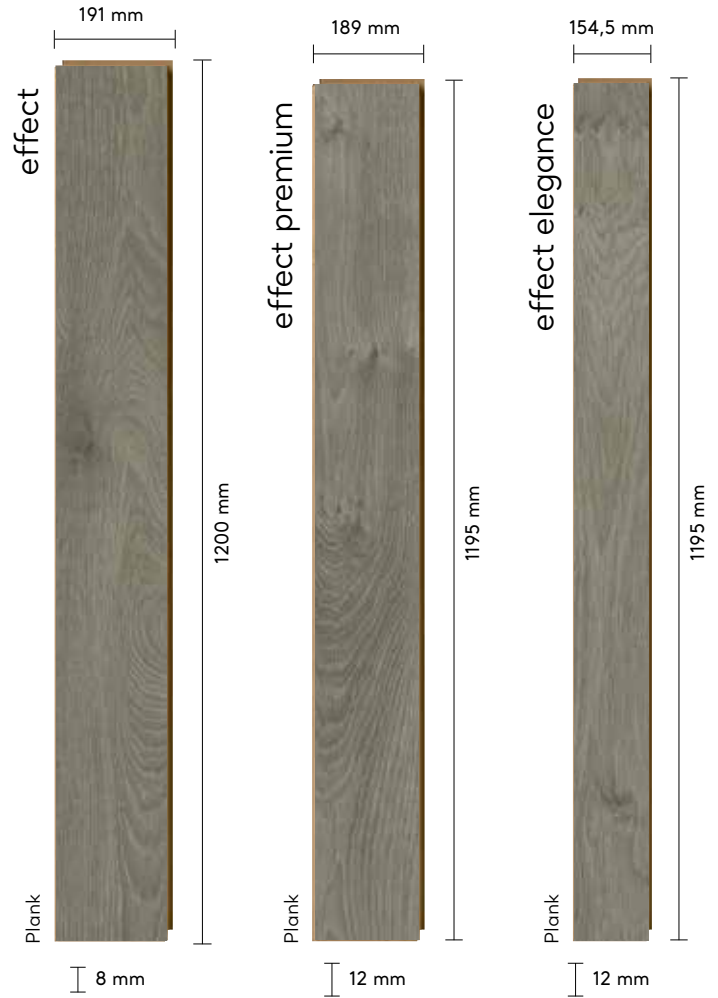

Kanada'nın doruklarından bir parça.
Yeniliğin ve ferahlığın zirvesinde yürüyün!

*A piece from Canada's peaks.
Walk at the peak of innovation
and refreshment!*





atlas



Dağların ve vadilerin arasında yürüyüş keyfini yaşayın, mekanınızda sıcak bir atmosfer yaratın.

Enjoy a unique walk between mountains and valleys, create a warm atmosphere in your place.

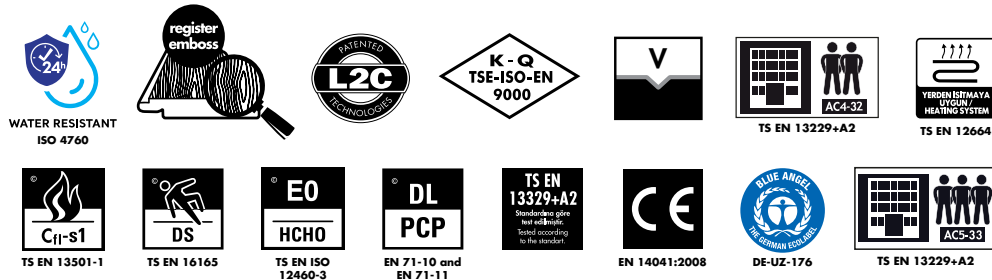

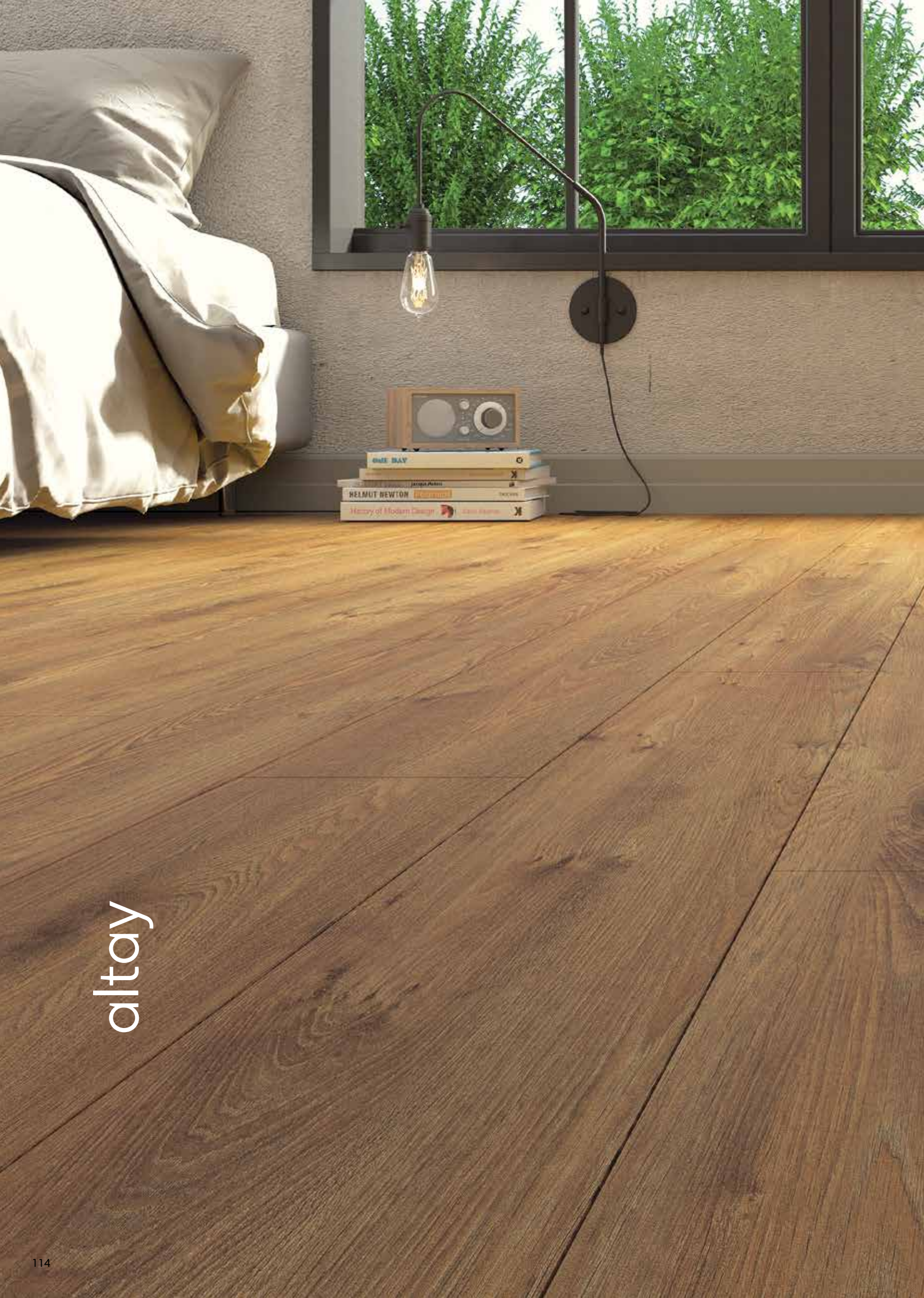

altay



Estetiğin doruk noktası!
Altın, demir, bakırla dolu sıradağların zengin renklerine ayak basın.

*The climax of aesthetics!
Take a step on to the rich colors of the mountain range filled with gold, iron and copper.*





pamir



Orta Asya'nın zirvelerinden bir parça!
Sıradağların eşsiz dekorlarıyla
mekanınızda doğanın keyfini çıkarın.

*A piece from the peaks of Central Asia!
Enjoy the nature vibes at your space with
the unique decors of the mountain range.*



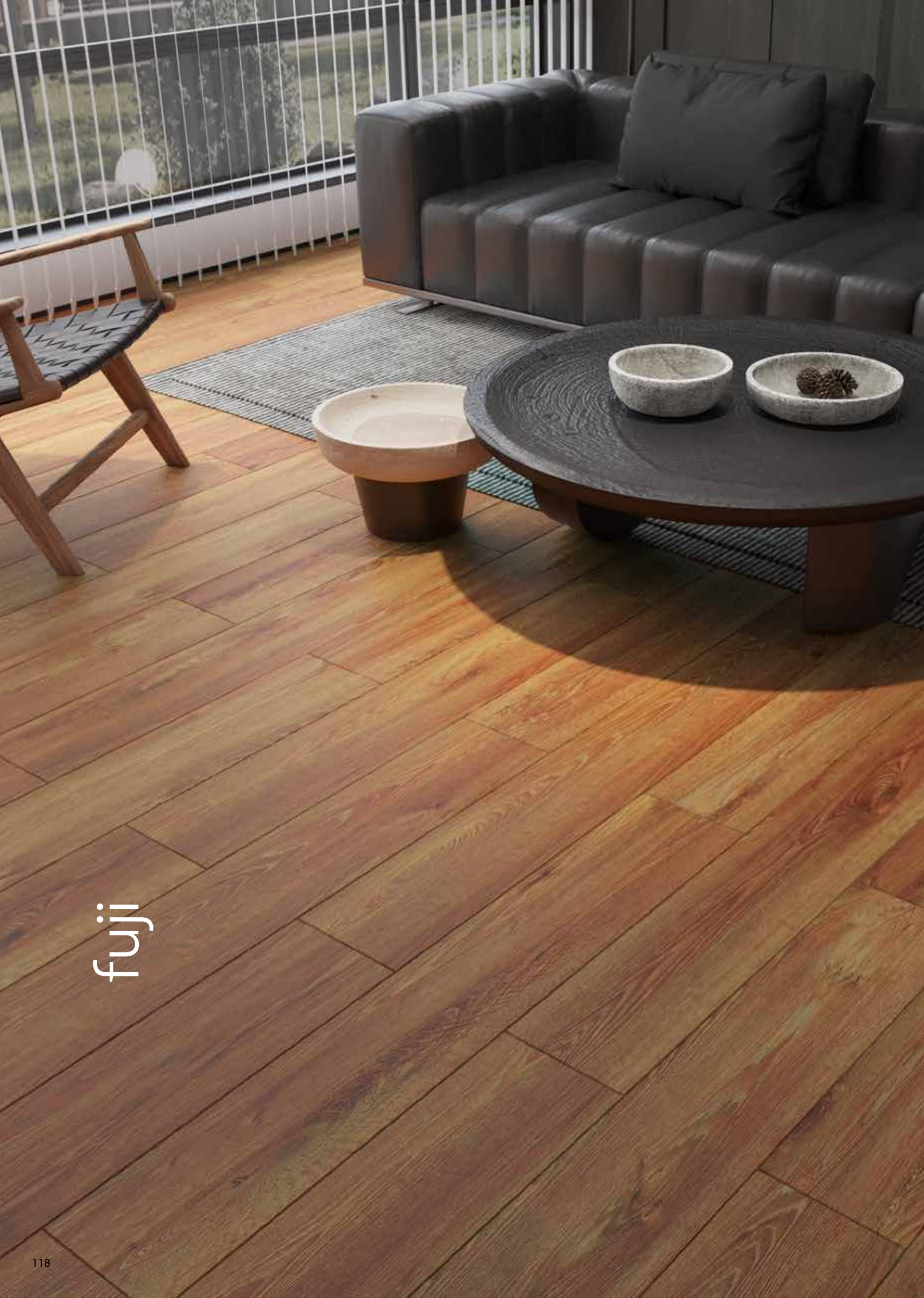

fuji



Gün batımının büyüleyici cazibesi!
Güneşin toprakla buluşan tonlarıyla
doğal bir görünüm elde edin.

*The charm of the sunset! Have a natural
look with shades of the sun meets
the soil.*

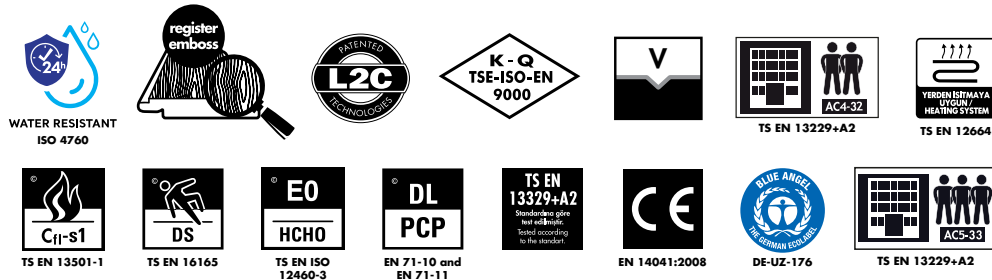



rosso



El değmemiş topraklardan ilham alan eşsiz bir dekor! Gün batımının sıcak esintilerini mekanınızda hissedin.

*A unique decor inspired by untouched lands!
Feel the warm breezes of the sunset
in your space.*





toros



Dağların koyu toprak zenginliğini keşfedin ve yaşam alanınızda arzuladığınız görünümü yakalayın.

Discover the richness of dark soil tones of mountains and have the look you desire in your living space.



EFFECT / EFFECT PREMIUM / EFFECT ELEGANCE TEKNİK ÖZELLİKLER

EFFECT / EFFECT PREMIUM / EFFECT ELEGANCE TECHNICAL SPECIFICATIONS

ÖZELLİKLER / SPECIFICATIONS	STANDART / STANDARD	SONUÇLAR / RESULTS
Elementler arası kalınlık farkı <i>Thickness difference between elements</i>	EN 13329	T ortalama < 0,50 mm t max-t min < 0,50 mm T average < 0,50 mm t max-t min < 0,50 mm
Aşınma dayanımı <i>Abrasion Resistance</i>	EN 438	Effect: Devir > 4000 Cycle > 4000 Effect Premium & Elegance: Devir > 6000 Cycle > 6000
Elementin baş kısım gönye sapması <i>Deviation from squareness of element</i>	EN 13329	Q max < 0,2mm
Yüzey tabakasının uzunluğu <i>Length tolerance</i>	EN 13329	l < 1500mm l fark < 0,5mm l < 1500mm l difference < 0,5mm
Yüzey tabakasının genişliği <i>Width tolerance</i>	EN 13329	W ortalama fark 0,10mm w max- w min < 0,20mm W average difference 0,10mm w max- w min < 0,20mm
Kılıcına dönme miktarı <i>Edgewise bending</i>	EN 13329	0,30 mm
Elementin yüzey düzgünlüğü <i>Element's surface smoothness</i>	EN 13329	Fw içbükey < %0,15 fw dışbükey < %0,20 F1 içbükey < %0,50 fl dışbükey < %1,00 Fw concave < %0,15 fw convex < %0,20 F1 concave < %0,50 fl convex < %1,00
Elementler arası açıklık <i>Space between elements</i>	EN 13329	O ortalama < 0,15mm o max 0,15mm O average < 0,15mm o max 0,15mm
Elementler arası yükseklik farkı <i>Height difference between elements</i>	EN 13329	H ortalama < 0,10mm H max < 0,15mm H average < 0,10mm H max < 0,15mm
Yüzey sağlamlığı <i>Surface soundness</i>	EN 13329	AC4 / AC5 ≥ 1,25 N/mm ²
Çizilme mukavemeti (N) <i>Scratch resistance</i>	EN 438	> 3,5
Işık haslılığı <i>Light fastness</i>	EN ISO 4892 - 2:200	EN 20105 - A02'ye göre gri ölçekte ≥ 4 maruz kalmayan ve maruz kalan örnek parça arasındaki renk kontrastı Colour contrast between unexposed and exposed sample part ≥ 4 of grey scale according to EN 20105 - A02
Çarpma mukavemeti <i>Impact resistance</i>	EN 13329	32. sınıf için IC2 / IC2 for 32th class 33. sınıf için IC3 / IC3 for 33th class
Koltuk tekerleği etkisi <i>Determination of the effect of a castor chair</i>	EN 425	Görünümde bir değişiklik veya zarar olmayacak No change or damage on appearance should occur
Mobilya ayağı etkisi <i>Determination of the effect of a castor furniture</i>	EN 424	Görülebilir zarar olmamalıdır. No visible damage should occur
Sıcak kaplara dayanıklılık <i>Resistance to hot pots</i>	EN 13329	Sınıf 4 / Class 4
Su buharına karşı dayanıklılık <i>Resistance to water vapor</i>	EN 13329	Sınıf 4 / Class 4
Leke tutmaya karşı dayanıklılık <i>Stain resistance</i>	EN 13329	Sınıf 5 / Class 5
24 saat suda şişme <i>24 hours swelling in thickness</i>	EN 13329	< %18
Yoğunluk <i>Density</i>	EN 323	AGT'ye özgü/Specific to AGT
Eğilme dayanımı <i>Bending strenght</i>	EN 317	40 N/mm ²
Elastikiyet modülü <i>Modulus of elasticity</i>	EN 310	3500 N/mm ²
Çekme dayanımı <i>Vertical internal bond</i>	EN 319	≥ 1,2 N/mm ²

AŞINMA SINIFLARI/ABRASION CLASSES

Az / Low

Yoğun / High

EFFECT PREMIUM

21

22

23

31

32

33

AC1

AC2

AC3

AC4

AC5

Ortalama aşınma değeri / Average abrasion value

> 900

>1500

>2000

>4000

>6000

AŞINMA SINIFLARI/ABRASION CLASSES

Az / Low

Yoğun / High

EFFECT PREMIUM

21

22

23

31

32

33

AC1

AC2

AC3

AC4

AC5

Ortalama aşınma değeri / Average abrasion value

> 900

>1500

>2000

>4000

>6000

AŞINMA SINIFLARI/ABRASION CLASSES

Az / Low

Yoğun / High

EFFECT ELEGANCE

21

22

23

31

32

33

AC1

AC2

AC3

AC4

AC5

Ortalama aşınma değeri / Average abrasion value

> 900

>1500

>2000

>4000

>6000



10 MM
FLOORING
PARKE

NEO

CONCEPT





Her zaman doğal, her zaman yenilikçi!

Concept Neo Parke Serisinin tasarımda fark yaratan dekor ve desenleriyle tanışın. Teknolojiyle buluşan trend dekorları sayesinde kusursuz ahşap dokusunu yaşam alanlarınızda hissedin.

Always natural, always innovative!

Meet the decors and patterns of Concept Neo Flooring Series which make a difference in the design. Feel the perfect wood texture in your living spaces thanks to its trend decors that meets technology.

concept neo

154,5 mm

1195 mm

Plank

10 mm

En Width	Boy Length	Kalınlık Thickness	Paket kg Package kg	Paket m ² Package m ²
154,5 mm	1195 mm	10 mm	~13,30	~1,4770

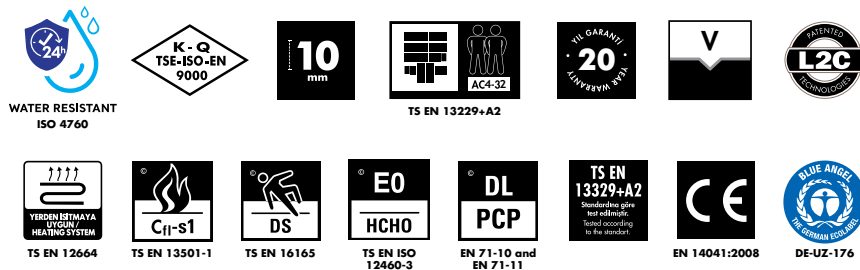

Kalınlık ± 0,30 mm değişiklik gösterebilmektedir.

Thickness can vary by ±0.30 mm.

CONCEPT NEO DEKORLAR

CONCEPT NEO DECORS

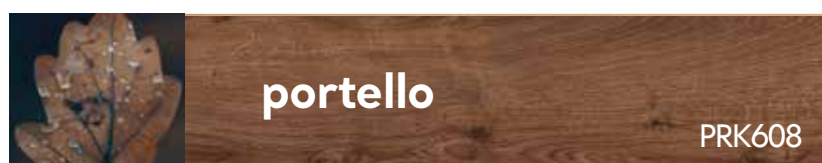
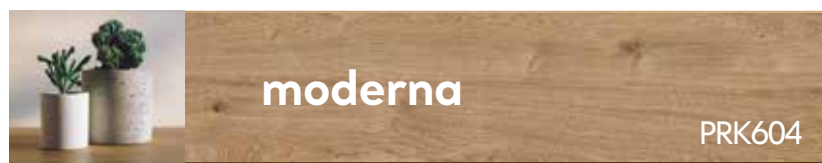

Dekor renkleri ile uyumlu zengin renk alternatiflerine sahip süpürelük çeşitleri bulunmaktadır.

There are skirting options and rich color alternatives that match the decor colors.



casella



Yenilikçi fikirlere yer açın!
Duyguları yöneten renklerle
dilediğiniz tasarımı kolayca yaratın.

*Make room for innovative ideas!
Easily create any design
with colors that effect emotions.*

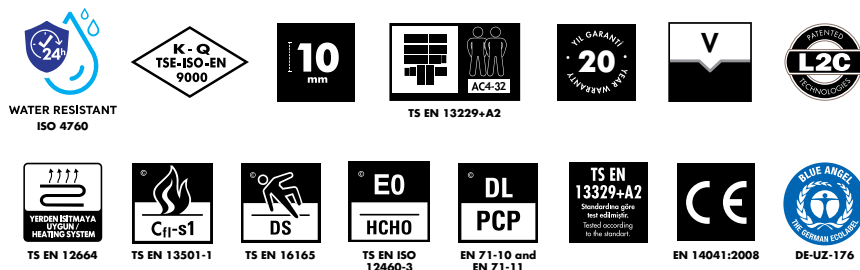



centro

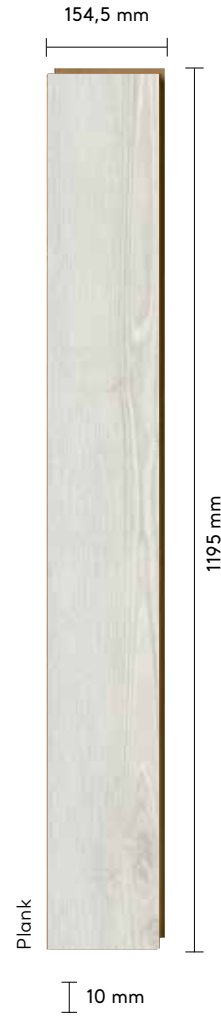

Her zaman estetik, her zaman trend!
Kusursuz dekoruyla uzun yıllar boyunca
modayı ve yeniliği yakalayın.

*Always aesthetic, always trendy!
With its impeccable decor
be fashionable for many years.*

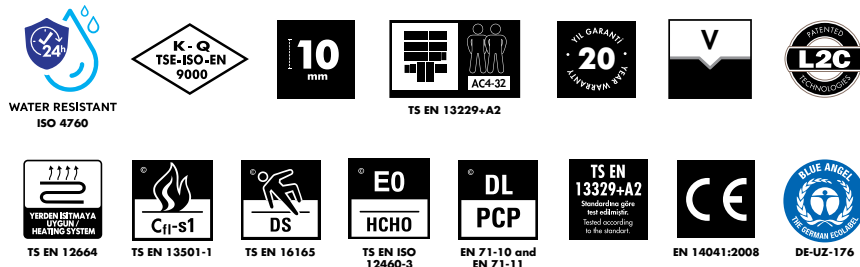



dorino



Tasarım, kültürlerden izler taşır!
İtalya'nın sıcak havasını
yaşam alanınızda yaşatın.

*Design has traces of cultures!
Experience the warm weather
of Italy in your living space.*

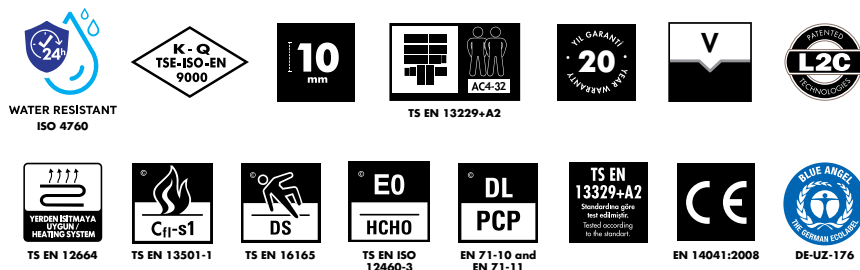



scala



Açık kahve, sıcak dekor!
Doğal ağaç damarlarına sahip yüzeyi
ve uzun ömürlü kullanımıyla
mekanınızı daima yeni tutun.

*Light brown, warm decor!
Always keep your space new
with its natural wood veins surface
and long-lasting use.*

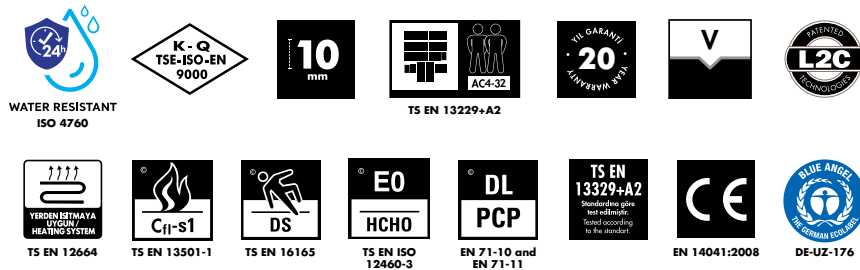



moderna



İyi bir yaşam için yenilikçi bir tasarım!
Kahverengi toprak tonlarının
doğal dokusunu mekanınızda hissedin.

*An innovative design for a better life!
Feel the natural texture of
brown earth tones in your space.*

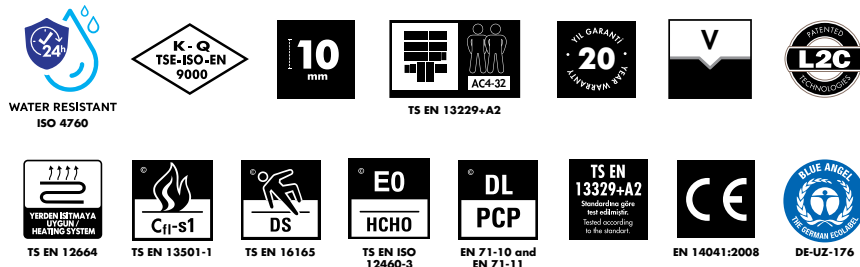



lima



Güney Afrika'nın sıcaklığı evinizde yaşasın!
Mutlu anlarınızı sıcaklığın modern tarzıyla
doldurun.

*Let the warmth of South Africa live in your
home! Fill your happy moments with the
modern style of warmth.*

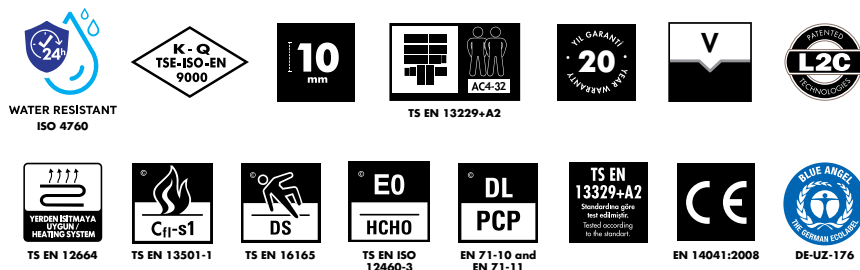



portello



Milano'nun sakin havasını evinize taşıyın!
Eskimeyen tarzıyla yıllar boyu yaşam alanınızı aydınlatın.

*Bring the calm air of Milan into your home!
Light up your living space for years with its timeless style.*

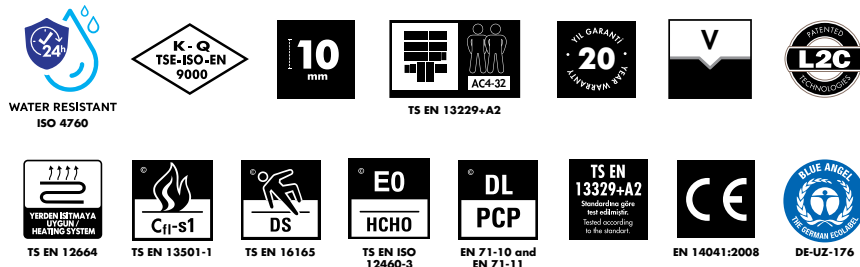



pero



Sıcak dekorun estetik dokunuşu!
Mekanınızın sıcaklığına modernliği ve şıklığı ekleyin.

*Aesthetic touch of warm decor!
Add modernity and elegance to the warmth of your space.*

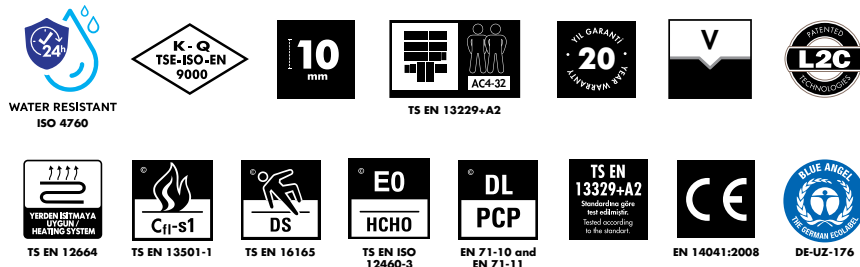

CONCEPT NEO TEKNİK ÖZELLİKLER CONCEPT NEO TECHNICAL SPECIFICATIONS

ÖZELLİKLER / SPECIFICATIONS	STANDART / STANDARD	SONUÇLAR / RESULTS
Elementler arası kalınlık farkı <i>Thickness difference between elements</i>	EN 13329	T ortalama< 0,50 mm t max-t min<0,50 mm <i>T average< 0,50 mm t max-t min<0,50 mm</i>
Aşınma dayanımı (AC4) <i>Abrasion Resistance (AC4)</i>	EN 13329	Devir>4000 <i>Cycle>4000</i>
Aşınma sınıfı <i>Abrasion Class</i>	EN 13329	32. Sınıf <i>32. Class</i>
Elementin baş kısım gönye sapması <i>Deviation from squareness of element</i>	EN 13329	Q max< 0,2mm
Yüzey tabakasının uzunluğu <i>Length tolerance</i>	EN 13329	l<1500mm l fark<0,5mm <i>l<1500mm l difference<0,5mm</i>
Yüzey tabakasının genişliği <i>Width tolerance</i>	EN 13329	W ortalama fark 0,10mm w max- w min<0,20mm <i>W average difference 0,10mm w max- w min<0,20mm</i>
Kılıcına dönme miktarı <i>Edgewise bending</i>	EN 13329	0,30 mm
Elementin yüzey düzgünlüğü <i>Element's surface smoothness</i>	EN 13329	Fw içbükey <%0,15 fw dışbükey <%0,20 F1 içbükey <%0,50 fl dışbükey <%1,00 <i>Fw concave <%0,15 fw convex <%0,20 F1</i> <i>concave <%0,50 fl convex <%1,00</i>
Elementler arası açıklık <i>Space between elements</i>	EN 13329	O ortalama<0,15mm o max 0,15mm <i>O avergae<0,15mm o max 0,15mm</i>
Elementler arası yükseklik farkı <i>Height difference between elements</i>	EN 13329	H ortalama< 0,10mm H max<0,15mm <i>H avergae< 0,10mm H max<0,15mm</i>
Yüzey sağlamlığı <i>Surface soundness</i>	EN 13329	AC4 ≥1,25 N/mm ²
Işık haslılığı <i>Light fastness</i>	EN ISO 4892 - 2:200	EN 20105 - A02'ye göre gri ölçekte ≥4 maruz kalmayan ve maruz kalan örnek parça arasındaki renk kontrastı <i>Colour contrast between unexposed and exposed sample part ≥4 of grey scale according to EN 20105 - A02</i>
Çarpma mukavemeti <i>Impact resistance</i>	EN 13329	32. sınıf için IC2 <i>IC2 for 32th class</i>
Koltuk tekerleği etkisi <i>Determination of the effect of a castor chair</i>	EN 425	Görünümde bir değişiklik veya zarar olmayacak <i>No change or damage on appearance should occur</i>
Çizilme mukavemeti (N) <i>Scratch resistance (N)</i>	EN438-2	≥3,5 N

ÖZELLİKLER / SPECIFICATIONS	STANDART / STANDARD	SONUÇLAR / RESULTS
Mobilya ayağı etkisi <i>Determination of the effect of a castor furniture</i>	EN 424	Görülebilir zarar olmamalıdır <i>No visible damage should occur</i>
Sıcak kaplara dayanıklılık <i>Resistance to hot pots</i>	EN 438-2	Sınıf 4 / Class 4
Su buharına karşı dayanıklılık <i>Resistance to water vapor</i>	EN 438-2	Sınıf 4 / Class 4
Leke tutmaya karşı dayanıklılık <i>Stain resistance</i>	EN 438-2	Sınıf 5 / Class 5
24 saat suda şişme <i>24 hours swelling in thickness</i>	EN 13329	<%18
Yoğunluk <i>Density</i>	EN 323	AGT'ye özgü/ <i>Specific to AGT</i>
Eğilme dayanımı <i>Bending strenght</i>	EN 317	40 N/mm ²
Elastikiyet modülü <i>Modulus of elasticity</i>	EN 310	3500 N/mm ²
Çekme dayanımı <i>Vertical internal bond</i>	EN 319	≥1,20 N/mm ²

AŞINMA SINIFLARI/ABRASION CLASSES

	Az / Low			Yoğun / High		
CONCEPT NEO	21	22	23	31	32	33
	AC1	AC2		AC3	AC4	AC5
Ortalama aşınma değeri / Average abrasion value	> 900	>1500		>2000	>4000	>6000

Renkler basılı ve dijital kataloglarda farklılık gösterebilir. Lütfen, satış noktalarımızda bulunan gerçek ürünler ile karşılaştırınız.

Colors may vary in digital and printed catalogs. Please compare with the actual products in the sales points.



8 MM
FLOORING
PARKE

ARMONIA

SLIM-LARGE



Özgün olmak, bazen tüm kalıpların dışına çıkmayı gerektirir.
Armonia Slim & Large Serilerini ister ayrı ayrı, ister bir arada
kullanabilirsiniz.

*Being innovative means not to follow patterns.
So, you can use Armonia Slim & Large Series seperately or
together, as a pattern.*



Her mekana uyan eşsiz tasarımlar!

Güney sahillerinin dokusundan ilham alan
Armonia Slim & Large Parke Serilerini keşfedin.

Dar ve geniş birlikte uygulanma seçeneği de sunan ve
ahşabın doğallığını taşıyan yüzey dokusuyla doğayı yaşam
alanlarınıza taşıyın.

Unique designs that suit to every place!

*Time to discover Armonia Flooring Series that inspired
by the texture of south coasts. Bring nature to your living
spaces with the surface texture that offers the option of
being applied separately or together and carries
the naturalness of wood.*



En Width	Boy Length	Kalınlık Thickness	Paket kg Package kg	Paket m ² Package m ²
246 mm	1380 mm	8 mm	~17,00	~2,3764
159 mm	1380 mm	8 mm	~15,70	~2,1942

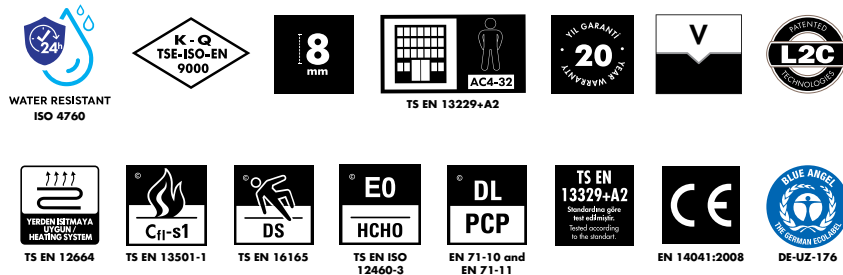

Kalınlık $\pm 0,30$ mm deęişiklik gösterebilmektedir.

Thickness can vary by ± 0.30 mm.

ARMONIA SLIM/LARGE DEKORLAR

ARMONIA SLIM/LARGE
DECORS

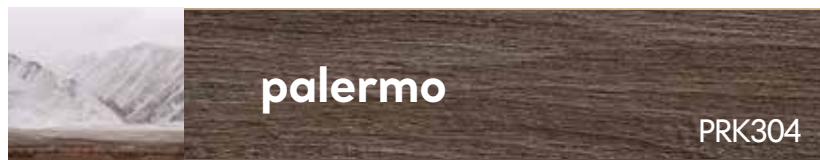
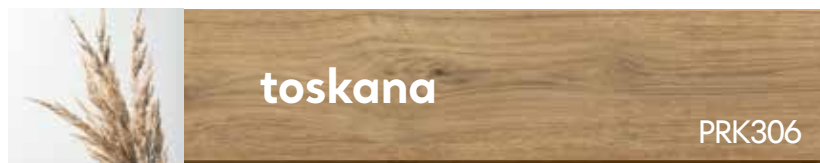
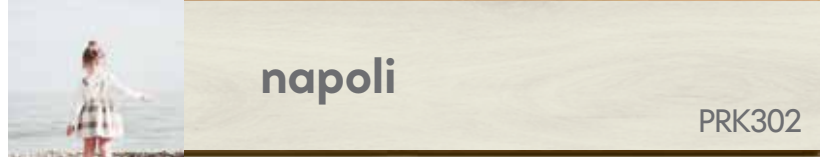

Dekor renkleri ile uyumlu zengin renk alternatiflerine sahip süpürgelik çeşitleri bulunmaktadır.

There are skirting options and rich color alternatives that match the decor colors.



napoli slim



napoli large

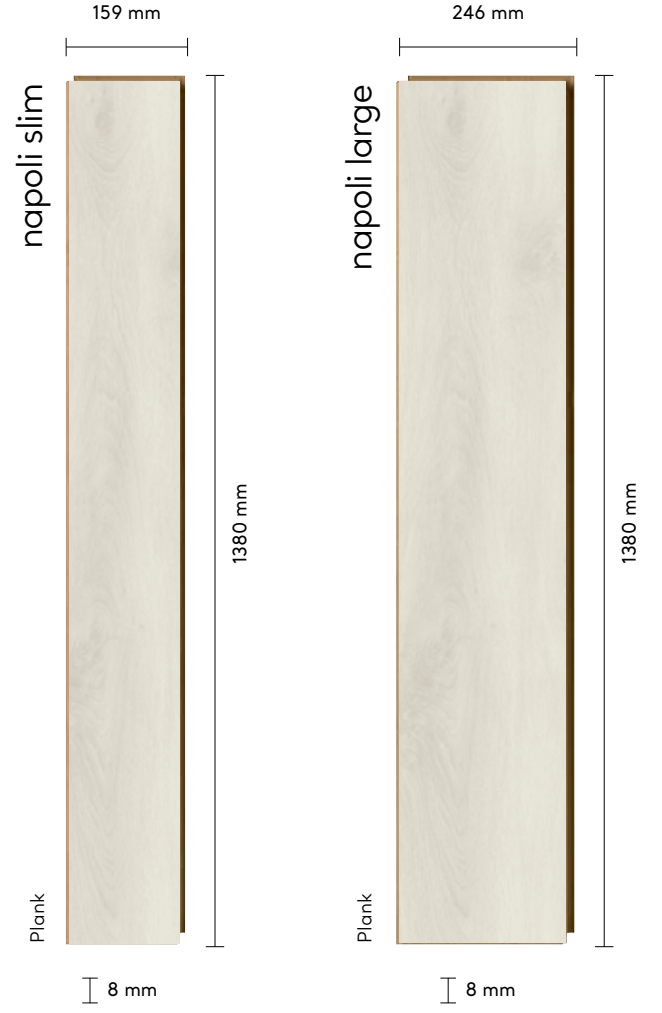

Özenli mekanlar, özenle tasarlanmış ürünler ister! Napoli şehrinin ferah mimarisini her adımınızda hissedin.

Attentive spaces require carefully designed products! Feel the spacious architecture of Naples city at any step.

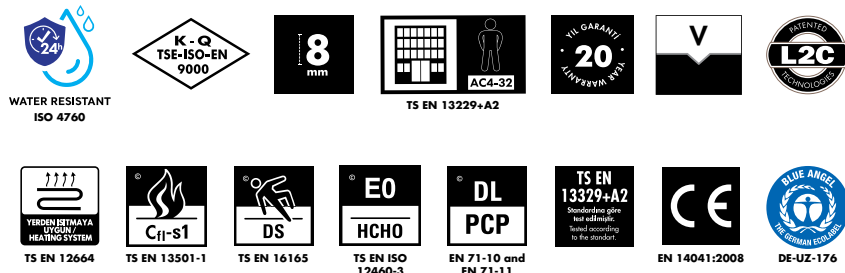



minori slim



minori large



Yaşadığınız her ana estetik bir dokunuş!
Sahil kasabasının ferahlatan doğasını ve mimarisini mekanınızda yaşayın.

*An aesthetic touch to any moment of life!
Experience the refreshing nature and architecture of the seaside town in your space.*

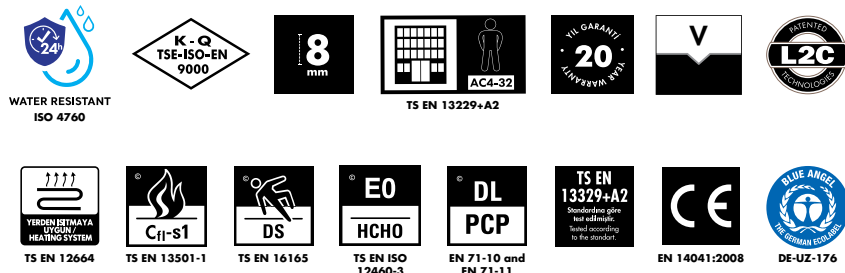

ravello slim



ravello large

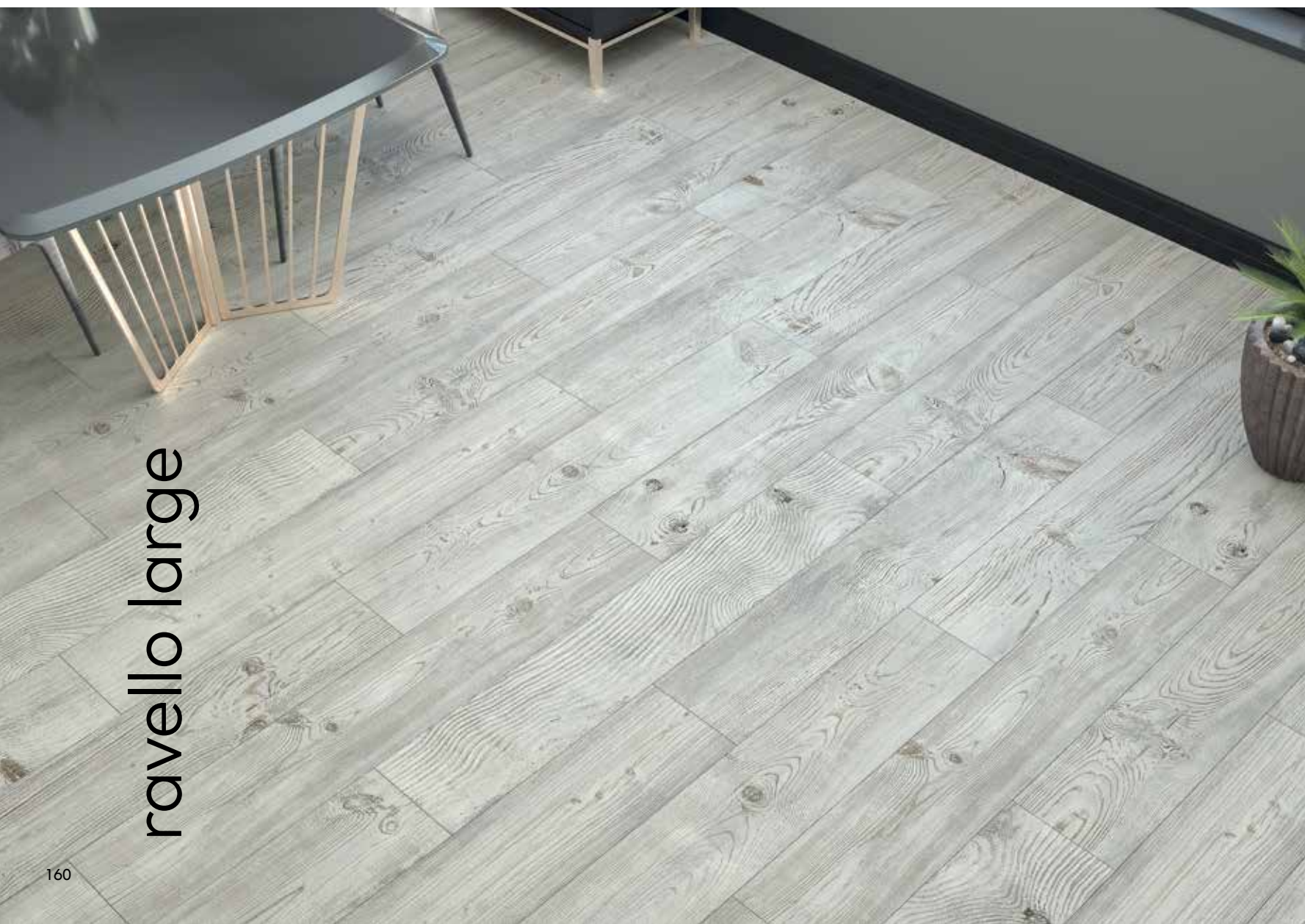



Ferah, sade ve şık!
Özlemini duyduğunuz huzuru
yaşam alanlarınıza taşıyın.

*Spacious, simple and stylish!
Bring the peace you desire
to your living spaces.*

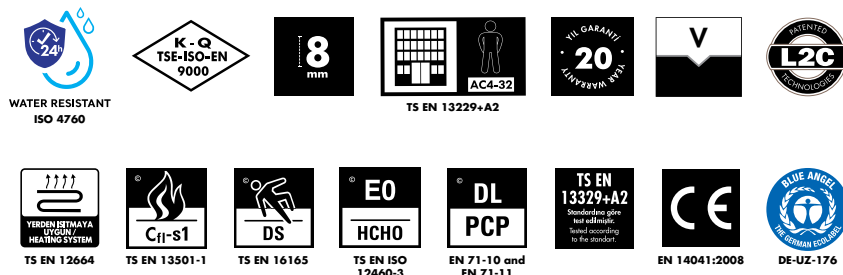



sorento slim



sorento large

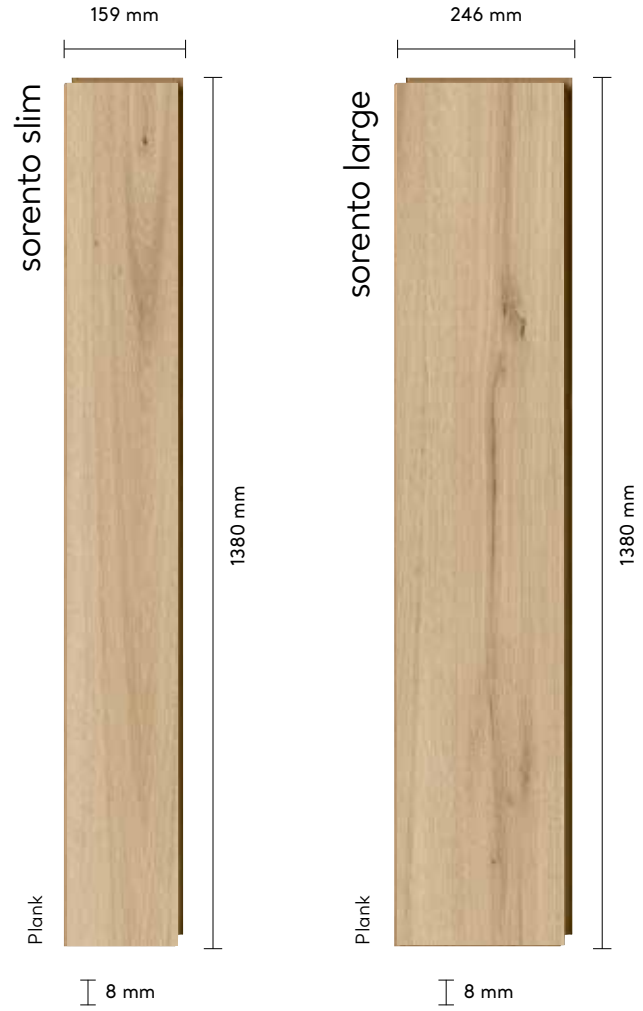

Keyifle yaşanacak anlar için!
Yaşam alanlarınızın görünümünü
küçük dokunuşlarla yenileyin
ve enerjinizi yükseltin.

*For moments of joy!
Renew the appearance of your living
spaces with small touches and
increase your energy.*

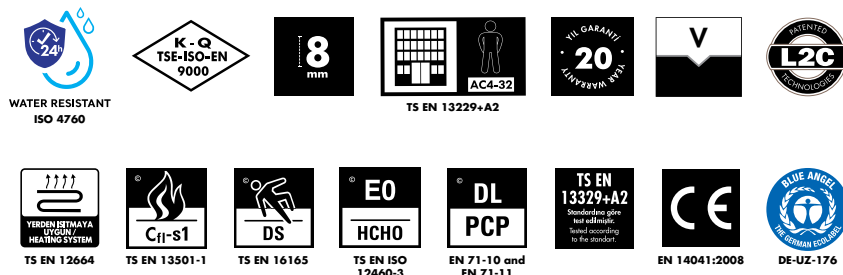

toskana slim



toskana large



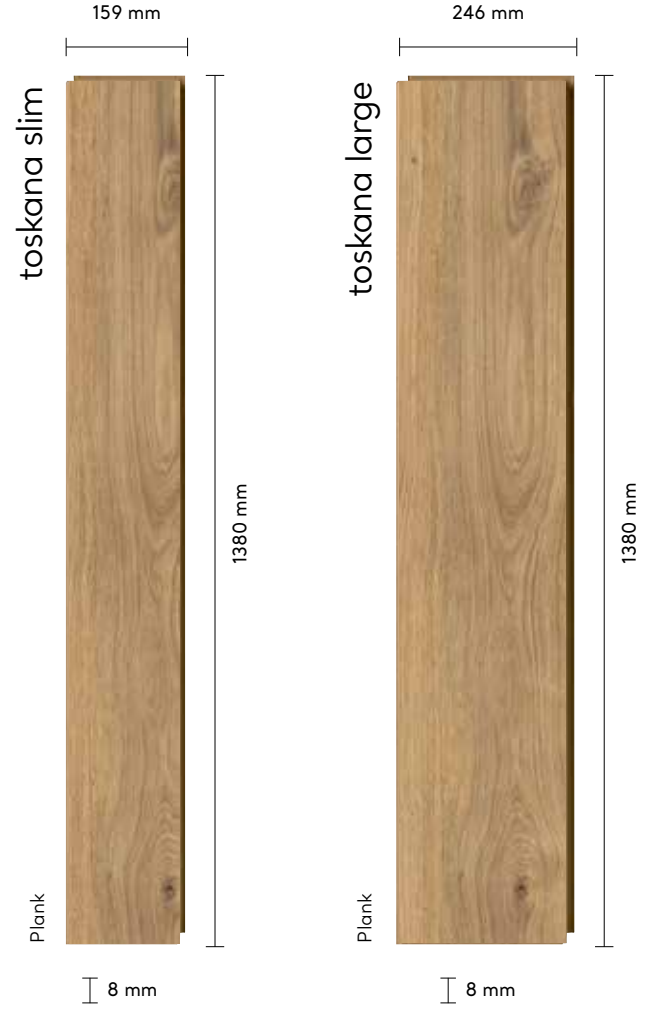

Ahşabın benzersiz doğal sıcaklığı!
Yaşam alanınızı yaz esintileriyle
dekore edin, toprak tonlarına adım atın.

*The unique natural warmth of wood!
Decorate your living space with
summer breezes and step into earth tones.*

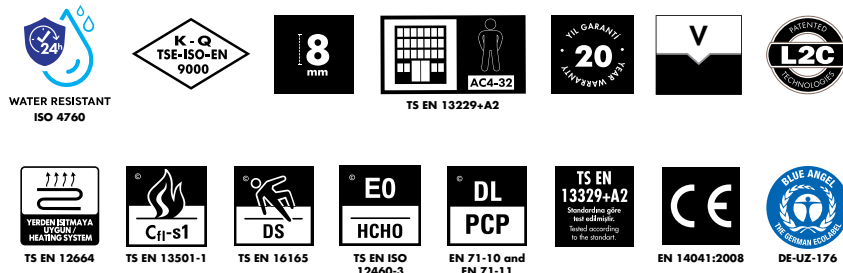



palermo slim



palermo large

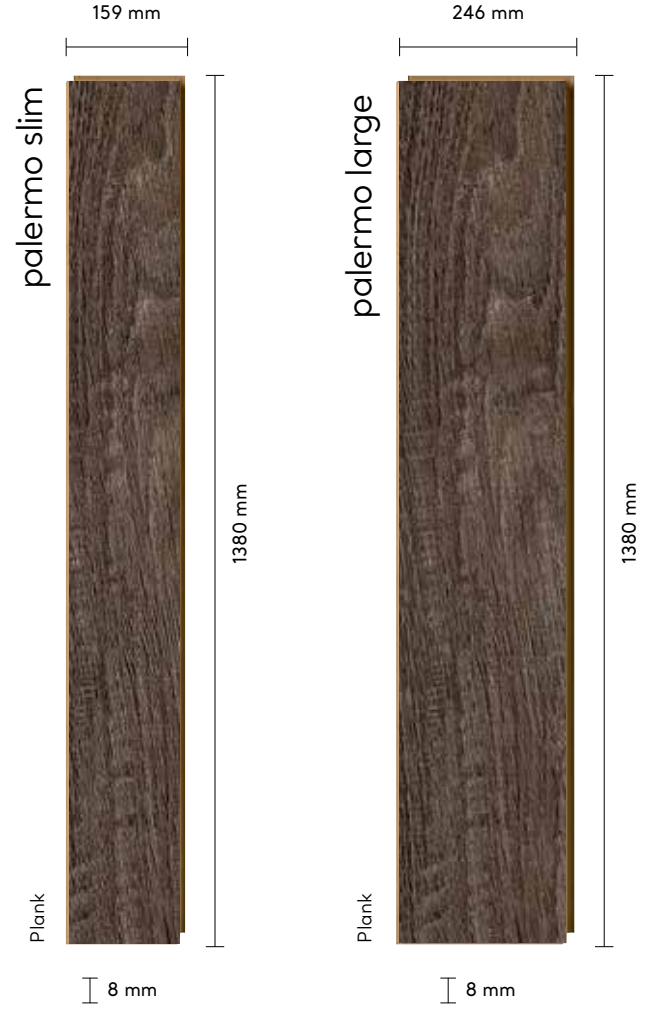

Koyu kahverengi toprak tonlar!
İnce detaylarıyla göz dolduran dekoruyla mekanınızda istediğiniz konforu yakalayın.

*Dark brown earth tones!
Have the comfort you want at your space with its eye-filling decor has fine details.*

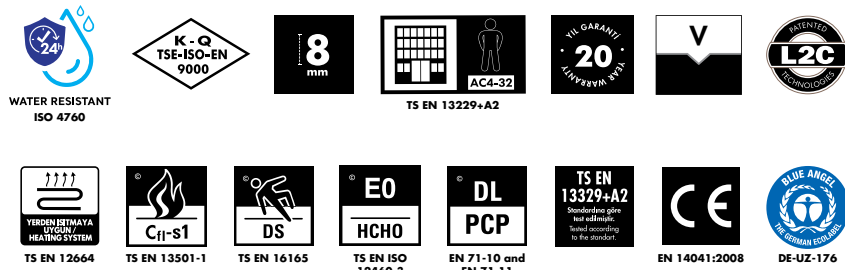

ARMONIA SLIM/LARGE TEKNİK ÖZELLİKLER

ARMONIA SLIM/LARGE TECHNICAL SPECIFICATIONS

ÖZELLİKLER / SPECIFICATIONS	STANDART / STANDARD	SONUÇLAR / RESULTS
Elementler arası kalınlık farkı <i>Thickness difference between elements</i>	EN 13329	T ortalama < 0,50 mm t max-t min < 0,50 mm T average < 0,50 mm t max-t min < 0,50 mm
Aşınma dayanımı <i>Abrasion Resistance</i>	EN 438	Devir > 4000 Cycle > 4000
Elementin baş kısmı gönye sapması <i>Deviation from squareness of element</i>	EN 13329	Q max < 0,2mm
Yüzey tabakasının uzunluğu <i>Length tolerance</i>	EN 13329	l < 1500mm l fark < 0,5mm l < 1500mm l difference < 0,5mm
Yüzey tabakasının genişliği <i>Width tolerance</i>	EN 13329	W ortalama fark 0,10mm w max- w min < 0,20mm W average difference 0,10mm w max- w min < 0,20mm
Kılıcına dönme miktarı <i>Edgewise bending</i>	EN 13329	0,30 mm
Elementin yüzey düzgünlüğü <i>Element's surface smoothness</i>	EN 13329	Fw içbükey < %0,15 fw dışbükey < %0,20 F1 içbükey < %0,50 fl dışbükey < %1,00 Fw concave < %0,15 fw convex < %0,20 F1 concave < %0,50 fl convex < %1,00
Elementler arası açıklık <i>Space between elements</i>	EN 13329	O ortalama < 0,15mm o max 0,15mm O average < 0,15mm o max 0,15mm
Elementler arası yükseklik farkı <i>Height difference between elements</i>	EN 13329	H ortalama < 0,10mm H max < 0,15mm H average < 0,10mm H max < 0,15mm
Yüzey sağlamlığı <i>Surface soundness</i>	EN 13329	AC4 ≥ 1,25 N/mm ²
Çizilme mukavemeti (N) <i>Scratch resistance</i>	EN 438	> 3,5
Işık hızlığı <i>Light fastness</i>	EN ISO 4892 - 2:200	EN 20105 - A02'ye göre gri ölçekte ≥ 4 maruz kalmayan ve maruz kalan örnek parça arasındaki renk kontrastı Colour contrast between unexposed and exposed sample part ≥ 4 of grey scale according to EN 20105 - A02
Çarpma mukavemeti <i>Impact resistance</i>	EN 13329	32. sınıf için IC2 IC2 for 32 nd class
Koltuk tekerleği etkisi <i>Determination of the effect of a castor chair</i>	EN 425	Görünümde bir değişiklik veya zarar olmayacak No change or damage on appearance should occur
Mobilya ayağı etkisi <i>Determination of the effect of a castor furniture</i>	EN 424	Görülebilir zarar olmamalıdır. No visible damage should occur
Sıcak kaplara dayanıklılık <i>Resistance to hot pots</i>	EN 13329	Sınıf 4 / Class 4
Su buharına karşı dayanıklılık <i>Resistance to water vapor</i>	EN 13329	Sınıf 4 / Class 4
Leke tutmaya karşı dayanıklılık <i>Stain resistance</i>	EN 13329	Sınıf 5 / Class 5
24 saat suda şişme <i>24 hours swelling in thickness</i>	EN 13329	< %18
Yoğunluk <i>Density</i>	EN 323	AGT'ye özgü/Specific to AGT
Eğilme dayanımı <i>Bending strenght</i>	EN 317	40 N/mm ²
Elastikiyet modülü <i>Modulus of elasticity</i>	EN 310	3500 N/mm ²
Çekme dayanımı <i>Vertical internal bond</i>	EN 319	≥ 1,2 N/mm ²

AŞINMA SINIFLARI/ABRASION CLASSES

	Az / Low				Yoğun / High	
ARMONIA SLIM/LARGE	21	22	23	31	32	33
	AC1	AC2	AC3		AC4	AC5
Ortalama aşınma değeri / Average abrasion value	> 900	>1500	>2000		>4000	>6000

Renkler basılı ve dijital kataloğlarda farklılık gösterebilir. Lütfen, satış noktalarımızda bulunan gerçek ürünler ile karşılaştırınız.

Colors may vary in digital and printed catalogs. Please compare with the actual products in the sales points.

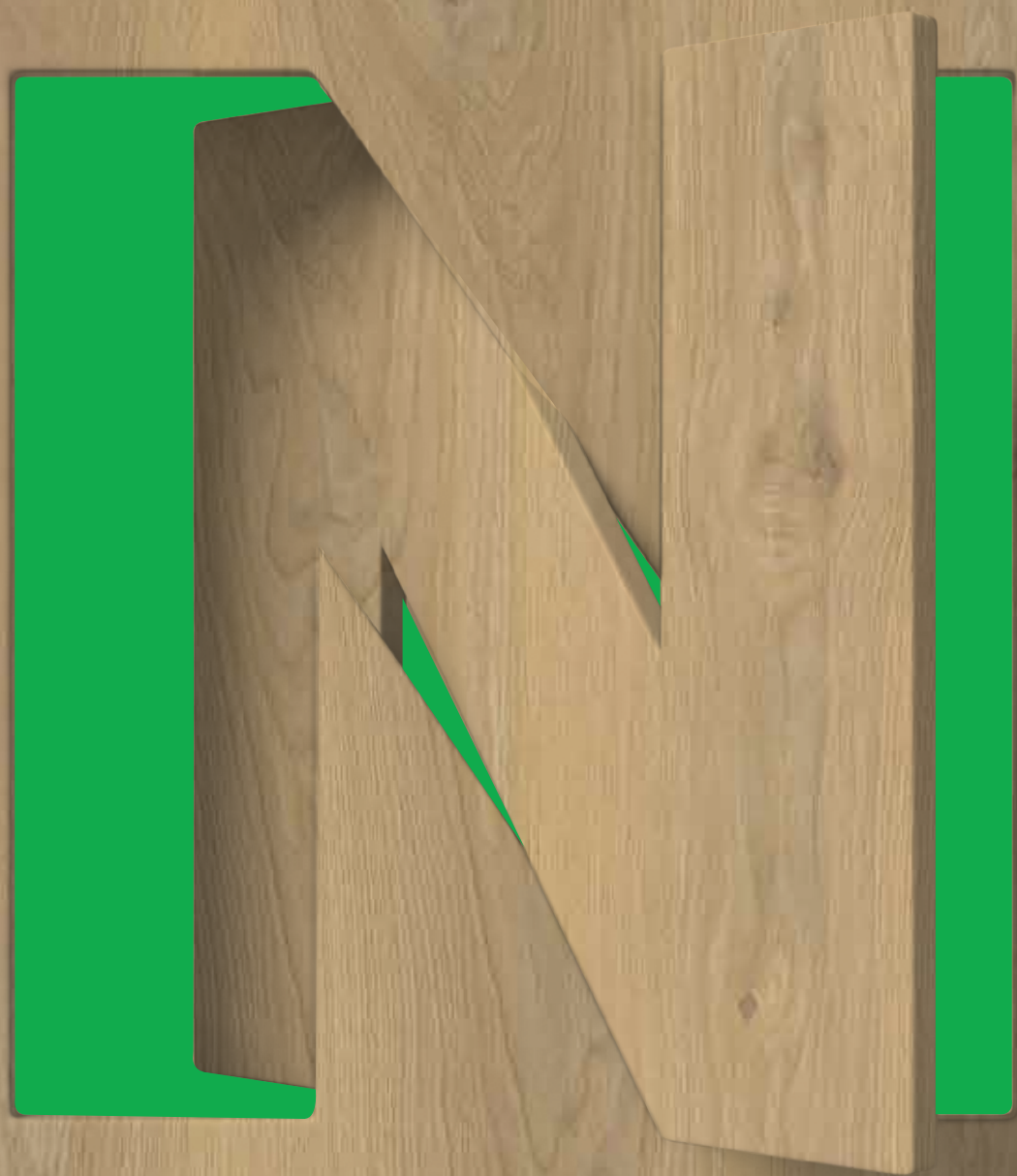

8 MM
FLOORING
PARKE

LINE

NATURA





Tasarım onun doğasında var!

Doğadan ilham alan tasarım ruhu, zamana meydan okuyan dayanıklı yapısı ve sıra dışı tasarım. Yeni bir trend yaratan Natura Line Parke Serisi ile yaşam alanlarınıza yenilik katın.

Design is in its nature!

Nature-inspired design spirit, time-defying durable construction and unusual design. Add innovation to your living spaces with the Natura Line Flooring Series, which creates a brand-new trend.

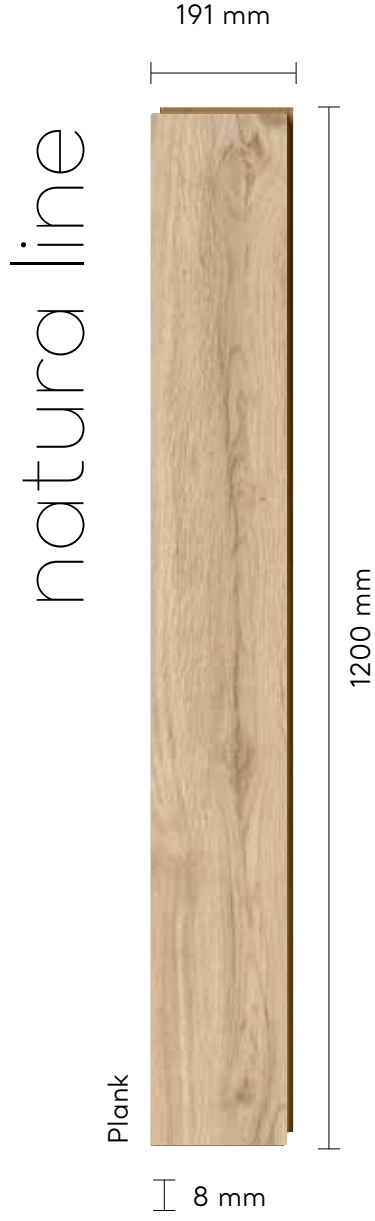

En Width	Boy Length	Kalınlık Thickness	Paket kg Package kg	Paket m ² Package m ²
191 mm	1200 mm	8 mm	~13,20	~1,8336

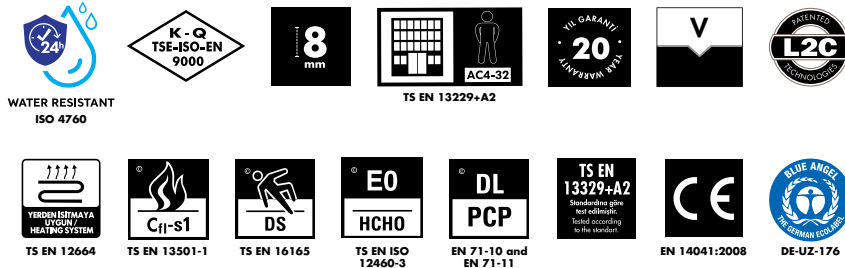

Kalınlık $\pm 0,30$ mm deęişiklik gösterebilmektedir.

Thickness can vary by ± 0.30 mm.

NATURA LINE DEKORLAR

NATURA LINE DECORS

Yeni
New



Yeni
New

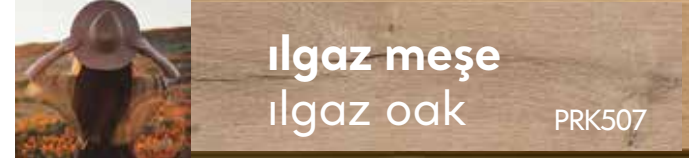

Dekor renkleri ile uyumlu zengin renk alternatiflerine sahip süpürgelik çeşitleri bulunmaktadır.

There are skirting options and rich color alternatives that match the decor colors.

yeni new

lena



Lena Kıyıları ayaklarınızın altında!
Adını Lena Kıyılarından renklerini buranın eşsiz bitki örtüsünden alan seri, her adımda doğallık ve zarafet arayanların tercihi.

*The Lena Shores beneath your feet!
This series, named after and colored by the unique flora of the Lena Shores, is the choice for those seeking naturalness and elegance with every step.*

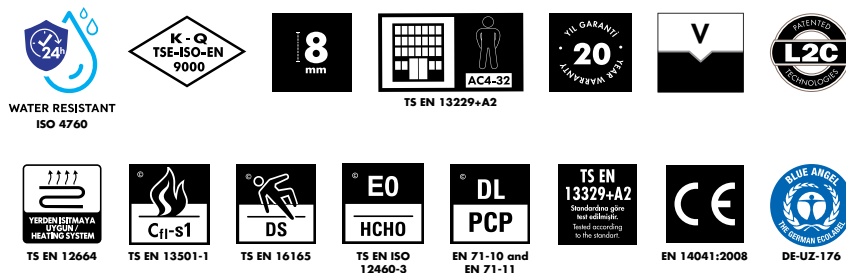



yeni new

gila

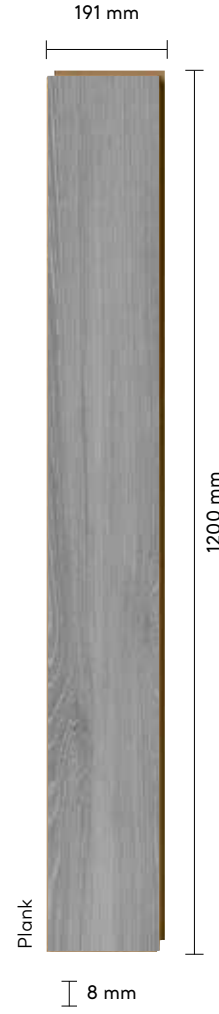

Gila ile daima doruklardasınız!
Adını Gila Dağları'dan alıyor; tasarımında ağaçların, kayaların ve bembeyaz karların doğallığını barındırıyor.

*You are always on the peak with Gila!
Named after the Gila Mountains, its design captures the natural elements of trees, rocks, and white snow.*



TS EN 12664

TS EN 13501-1

TS EN 16165

TS EN ISO 12460-3

EN 71-10 and EN 71-11

Standartına göre test edilmiştir. Testler standarta göre yapılmıştır.

EN 14041:2008

DE-UZ-176



nil
nile



Geçmişten geleceğe yenilikçi bir trend!
Uygarlıkların doğuşuna tanık olan Nil Nehri'nin
doğal izlerine yaşam alanınızda dokununuz.

*An innovative trend from past to future!
Touch the natural traces of the Nile River
in your place, where has witnessed
the birth of civilizations.*

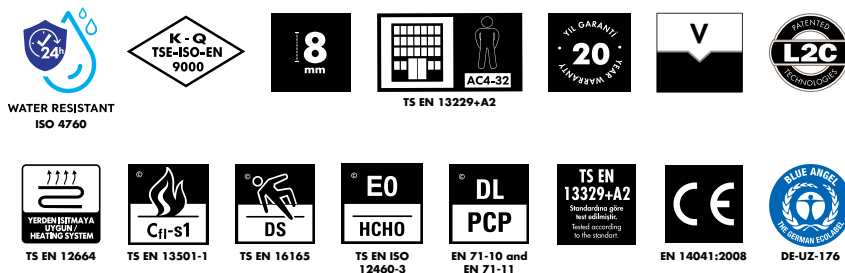



volga



Nehirler, her akışta kendini yeniler!
Avrupa'nın en uzun nehrinin ferahlığını
ve iç açan rengini yaşam alanınızda keşfedin.

*Rivers refresh themselves with every flow!
Discover the freshness and relaxing color
of the longest river of Europe
in your living spaces.*



kanyon meşe
canyon oak



Doğa, dünyanın baş sanatçısıdır!
Kanyon vadilerinin kendini yenileyen formuyla birleşen meşenin dayanıklılığını mekanınızda yaşatın.

*Nature is the chief artist of the world!
Experience the durability of oak in your space that combined with the self-renewing form of canyon valleys.*





tuna



Ahşabın teknolojiyle dansı!
Vals dansının doğduğu toprakların ritmini
ve Tuna Nehri'nin akışkan huzurunu
mekanınızda hissedin.

*The dance of wood with technology!
Feel the rhythm of the land where
the waltz dance was born and the fluid
peace of the Danube River in your place.*



saldada meşe
saldada oak



Doğanın eşsiz güzelliğinden bir parça!
Türkiye'nin beyaz incisi Salda Gölü'nün
bembeyaz kumlarının ferahlığını
yaşam alanlarınızda hissedin.

*A piece of nature's unique beauty!
Feel the freshness of the snow-white sands
of Lake Salda, the White Pearl of Turkey,
in your living spaces.*

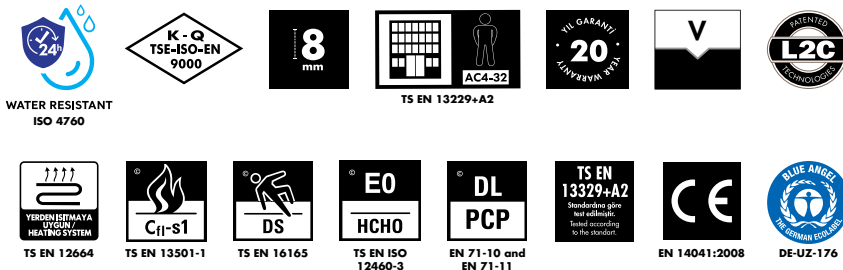



meriç
meric



Sınırları kaldıran benzersiz bir tasarım!
Kültürleri bir araya getiren Meriç Nehri'nin
toprak tonlarını mekanınıza taşıyın.

*A unique design that lifts boundaries!
Have cool earth tones of Meriç River which
brings cultures together at your place.*

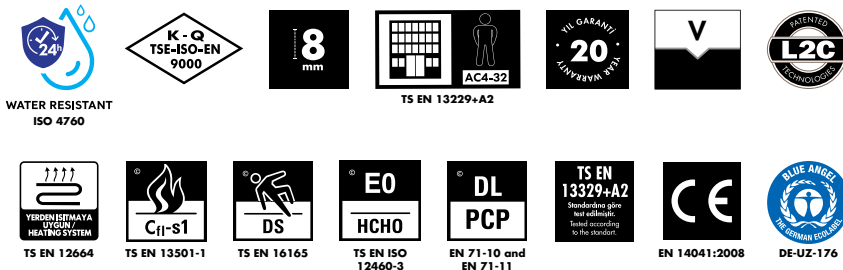

gala meşe
gala oak



Sakin, huzurlu ve davetkâr!
Kuş cenneti Gala Gölü'nün sarıya çalan
bitkilerinin sıcak tonlarını mekanınıza taşıyın.

*Calm, peaceful and inviting!
Bring warm tones of the yellowish plants of
bird's paradise Gala Lake to your place.*

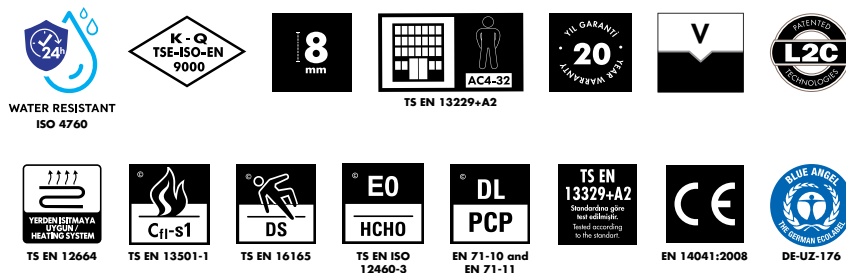

ilgaz meşe
ilgaz oak



Her zaman yeni, her sezon büyüleyici bir dekor!
Ilgaz Dağı'nın etkileyici havasını ve tonlarını mekanınızda konuk edin.

*Always new, a charming decor in every season!
Enjoy the impressive air and tones of Ilgaz Mountain in your place.*





trend meşe
trend oak



Ufuk açan yenilikçi dekor!
Trendleri değiştiren doğal ve ılık tonuyla yaşam alanlarınızda farklı bir atmosfer yaratın.

*Innovative decor that opens up new horizon!
Create a different atmosphere in your living spaces with its natural and warm tones that challenges and changes trends.*

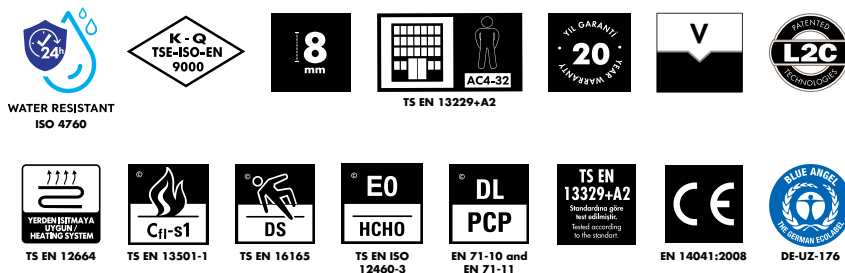



rodos



Yaşama iz bırakan doğal bir esinti!
Akdeniz'in sıcak tonlarını ve enerjisini
mekanınıza getirin.

*A natural breeze that leaves a mark on life!
Bring the warm tones and energy
of the Mediterranean to your place.*

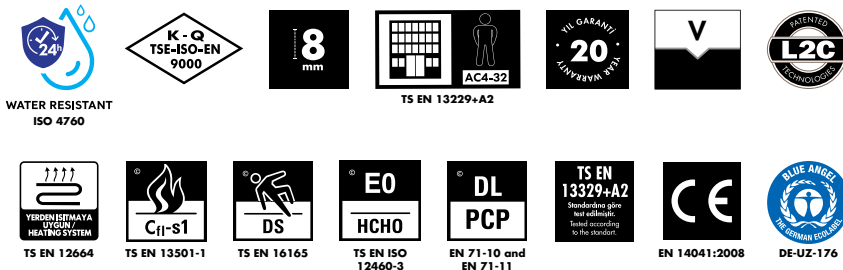



selge



Antik kentlerden estetik bir parça!
Zirvelere kurulmuş Selge dağ kentinin
mistik renklerini mekanınızda yakalayın.

*An aesthetic piece from ancient cities!
Have the mystical colors of the
mountain city of Selge in your space.*

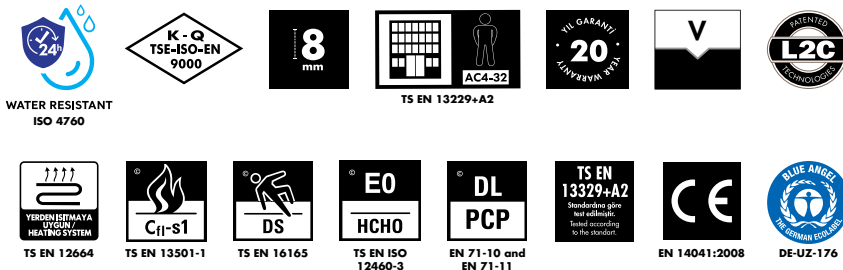



talya



Bahar, doğanın uyanışıdır!
Baharın tonlarını ve doğanın canlanan renklerini yaşam alanlarınızda hissedin.

*Spring is the awakening of the nature!
Feel the tones of spring and the revitalizing colors of nature in your living spaces.*

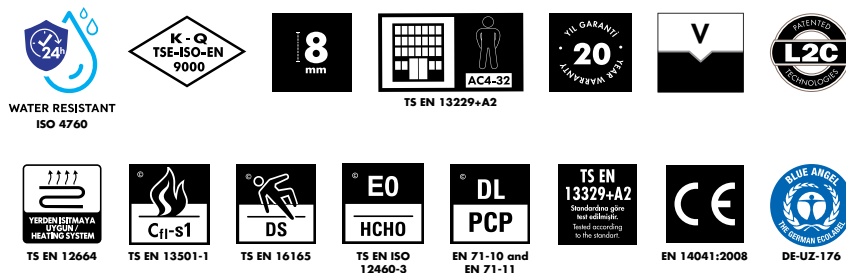

NATURA LINE PARKE TEKNİK ÖZELLİKLER

NATURA LINE FLOORING TECHNICAL SPECIFICATIONS

ÖZELLİKLER / SPECIFICATIONS	STANDART / STANDARD	SONUÇLAR / RESULTS
Elementler arası kalınlık farkı <i>Thickness difference between elements</i>	EN 13329	T ortalama < 0,50 mm t max-t min < 0,50 mm <i>T average < 0,50 mm t max-t min < 0,50 mm</i>
Aşınma dayanımı <i>Abrasion Resistance</i>	EN 438	Devir > 4000 <i>Cycle > 4000</i>
Elementin baş kısım gönye sapması <i>Deviation from squareness of element</i>	EN 13329	Q max < 0,2mm
Yüzey tabakasının uzunluğu <i>Length tolerance</i>	EN 13329	l < 1500mm l fark < 0,5mm <i>l < 1500mm l difference < 0,5mm</i>
Yüzey tabakasının genişliği <i>Width tolerance</i>	EN 13329	W ortalama fark 0,10mm w max- w min < 0,20mm <i>W average difference 0,10mm w max- w min < 0,20mm</i>
Kılıcına dönme miktarı <i>Edgewise bending</i>	EN 13329	0,30 mm
Elementin yüzey düzgünlüğü <i>Element's surface smoothness</i>	EN 13329	Fw içbükey < %0,15 fw dışbükey < %0,20 F1 içbükey < %0,50 fl dışbükey < %1,00 <i>Fw concave < %0,15 fw convex < %0,20 F1 concave < %0,50 fl convex < %1,00</i>
Elementler arası açıklık <i>Space between elements</i>	EN 13329	O ortalama < 0,15mm o max 0,15mm <i>O average < 0,15mm o max 0,15mm</i>
Elementler arası yükseklik farkı <i>Height difference between elements</i>	EN 13329	H ortalama < 0,10mm H max < 0,15mm <i>H average < 0,10mm H max < 0,15mm</i>
Yüzey sağlamlığı <i>Surface soundness</i>	EN 13329	AC4 ≥ 1,25 N/mm ²
Çizilme mukavemeti (N) <i>Scratch resistance</i>	EN 438	> 3,5
Işık haslılığı <i>Light fastness</i>	EN ISO 4892 - 2:200	EN 20105 - A02'ye göre gri ölçekte ≥ 4 maruz kalmayan ve maruz kalan örnek parça arasındaki renk kontrastı <i>Colour contrast between unexposed and exposed sample part ≥ 4 of grey scale according to EN 20105 - A02</i>
Çarpma mukavemeti <i>Impact resistance</i>	EN 13329	32. sınıf için IC2 <i>IC2 for 32th class</i>
Koltuk tekerleği etkisi <i>Determination of the effect of a castor chair</i>	EN 425	Görünümde bir değişiklik veya zarar olmayacak <i>No change or damage on appearance should occur</i>
Mobilya ayağı etkisi <i>Determination of the effect of a castor furniture</i>	EN 424	Görülebilir zarar olmamalıdır. <i>No visible damage should occur</i>
Sıcak kaplara dayanıklılık <i>Resistance to hot pots</i>	EN 13329	Sınıf 4 / Class 4
Su buharına karşı dayanıklılık <i>Resistance to water vapor</i>	EN 13329	Sınıf 4 / Class 4
Leke tutmaya karşı dayanıklılık <i>Stain resistance</i>	EN 13329	Sınıf 5 / Class 5
24 saat suda şişme <i>24 hours swelling in thickness</i>	EN 13329	< %18
Yoğunluk <i>Density</i>	EN 323	AGT'ye özgü/Specific to AGT
Eğilme dayanımı <i>Bending strenght</i>	EN 317	40 N/mm ²
Elastikiyet modülü <i>Modulus of elasticity</i>	EN 310	3500 N/mm ²
Çekme dayanımı <i>Vertical internal bond</i>	EN 319	≥ 1,2 N/mm ²

AŞINMA SINIFLARI/ABRASION CLASSES

NATURA LINE	Az / Low				Yoğun / High	
	21	22	23	31	32	33
	AC1	AC2	AC3	AC4	AC5	
Ortalama aşınma değeri / Average abrasion value	> 900	>1500	>2000	>4000	>6000	

Renkler basılı ve dijital kataloglarda farklılık gösterebilir. Lütfen, satış noktalarımızda bulunan gerçek ürünler ile karşılaştırınız.

Colors may vary in digital and printed catalogs. Please compare with the actual products in the sales points.



8 MM
FLOORING
PARKE

PRUVA





Zengin tonların büyüleyici etkisi!

Chevron desene yeni bir yorum sunan Pruva, yaşam alanlarında çok doğal ve bir o kadar da canlı bir görünüm elde etmenizi sağlar.

Fascinating effect of rich tones!

Pruva that offers a new interpretation of chevron pattern design. It allows you to have a very natural and vibrant look in your living spaces.



En Width	Boy Length	Kalınlık Thickness	Paket kg Package kg	Paket m ² Package m ²
188 mm	1200 mm	8 mm	~12,90	~1,8048

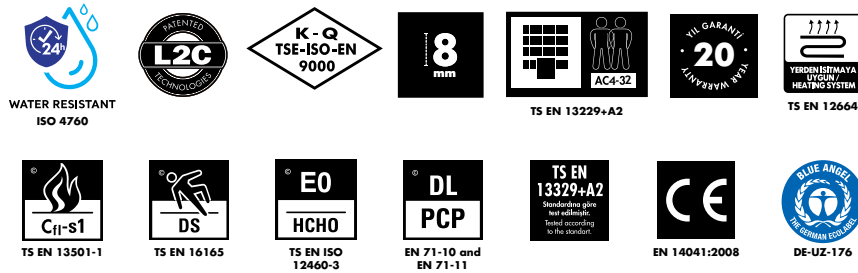

Kalınlık $\pm 0,30$ mm deęişiklik gösterebilmektedir.

Thickness can vary by ± 0.30 mm.

PRUVA DEKORLAR

PRUVA DECORS



Dekor renkleri ile uyumlu zengin renk alternatiflerine sahip süpügelik çeşitleri bulunmaktadır.

There are skirting options and rich color alternatives that match the decor colors.



alesta

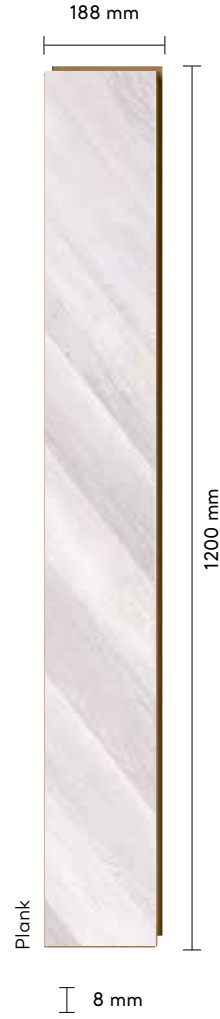

Evinizde modernliğe yelken açın!
Sakin bir dekorla huzuru yakalayın.

*Sail to modernity in your home!
Find peace with a calm decor.*

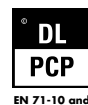

WATER RESISTANT
ISO 4760

TS EN 13329+A2

TS EN 12664

TS EN 13501-1

TS EN 16165

TS EN ISO
12460-3

EN 71-10 and
EN 71-11

EN 14041:2008

DE-UZ-176



likya



Akdeniz'in eşsiz doğası ve tarihinden esinlenen Likya ile doğallığı mekanınızda yaşayın.

Live the naturalness at your place with Likya which inspired by the unique nature and history of the Mediterranean.





cenova

Pruva



Evinizi, canlılık ve ferahlık katan dekorun büyüü ile aydınlatın.

Light up your home with the magic of decor that adds vitality and comfort.



WATER RESISTANT
ISO 4760



TS EN 13329+A2



TS EN 12664



TS EN 13501-1



TS EN 16165



TS EN ISO
12460-3



EN 71-10 and
EN 71-11



TS EN 13329+A2



EN 14041:2008



DE-UZ-176



parima



Plank

8 mm



İçinizi açan modernlik!
Deniz esintilerinin ferahlatıcı etkisini evinizde hissedin.

*Modernity that opens your heart!
Feel the refreshing effect of sea breezes at home.*





patalya



Şıklığın derinliğindeki dekor!
Değerini yıllar boyu koruyan eşsiz tasarımla
evine deniz havası kat.

*Decor in the depth of elegance!
Add sea air to your home with a unique
design that preserves its value for years.*

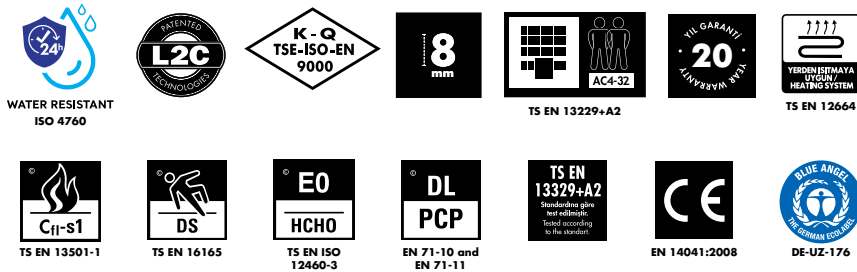

PRUVA TEKNİK ÖZELLİKLER PRUVA TECHNICAL SPECIFICATIONS

ÖZELLİKLER / SPECIFICATIONS	STANDART / STANDARD	SONUÇLAR / RESULTS
Elementler arası kalınlık farkı <i>Thickness difference between elements</i>	EN 13329	T ortalama < 0,50 mm t max-t min < 0,50 mm T average < 0,50 mm t max-t min < 0,50 mm
Aşınma dayanımı <i>Abrasion Resistance</i>	EN 438	Devir > 4000 Cycle > 4000
Elementin baş kısmı gönye sapması <i>Deviation from squareness of element</i>	EN 13329	Q max < 0,2mm
Yüzey tabakasının uzunluğu <i>Length tolerance</i>	EN 13329	l < 1500mm l fark < 0,5mm l < 1500mm l difference < 0,5mm
Yüzey tabakasının genişliği <i>Width tolerance</i>	EN 13329	W ortalama fark 0,10mm w max- w min < 0,20mm W average difference 0,10mm w max- w min < 0,20mm
Kılıcına dönme miktarı <i>Edgewise bending</i>	EN 13329	0,30 mm
Elementin yüzey düzgünlüğü <i>Element's surface smoothness</i>	EN 13329	Fw içbükey < %0,15 fw dışbükey < %0,20 F1 içbükey < %0,50 fl dışbükey < %1,00 Fw concave < %0,15 fw convex < %0,20 F1 concave < %0,50 fl convex < %1,00
Elementler arası açıklık <i>Space between elements</i>	EN 13329	O ortalama < 0,15mm o max 0,15mm O average < 0,15mm o max 0,15mm
Elementler arası yükseklik farkı <i>Height difference between elements</i>	EN 13329	H ortalama < 0,10mm H max < 0,15mm H average < 0,10mm H max < 0,15mm
Yüzey sağlamlığı <i>Surface soundness</i>	EN 13329	AC4 ≥ 1,25 N/mm ²
Çizilme mukavemeti (N) <i>Scratch resistance</i>	EN 438	> 3,5
Işık hızlığı <i>Light fastness</i>	EN ISO 4892 - 2:200	EN 20105 - A02'ye göre gri ölçekte ≥ 4 maruz kalmayan ve maruz kalan örnek parça arasındaki renk kontrastı Colour contrast between unexposed and exposed sample part ≥ 4 of grey scale according to EN 20105 - A02
Çarpma mukavemeti <i>Impact resistance</i>	EN 13329	32. sınıf için IC2 IC2 for 32 nd class
Koltuk tekerleği etkisi <i>Determination of the effect of a castor chair</i>	EN 425	Görünümde bir değişiklik veya zarar olmayacak No change or damage on appearance should occur
Mobilya ayağı etkisi <i>Determination of the effect of a castor furniture</i>	EN 424	Görülebilir zarar olmamalıdır. No visible damage should occur
Sıcak kaplara dayanıklılık <i>Resistance to hot pots</i>	EN 13329	Sınıf 4 / Class 4
Su buharına karşı dayanıklılık <i>Resistance to water vapor</i>	EN 13329	Sınıf 4 / Class 4
Leke tutmaya karşı dayanıklılık <i>Stain resistance</i>	EN 13329	Sınıf 5 / Class 5
24 saat suda şişme <i>24 hours swelling in thickness</i>	EN 13329	< %18
Yoğunluk <i>Density</i>	EN 323	AGT'ye özgü/Specific to AGT
Eğilme dayanımı <i>Bending strenght</i>	EN 317	40 N/mm ²
Elastikiyet modülü <i>Modulus of elasticity</i>	EN 310	3500 N/mm ²
Çekme dayanımı <i>Vertical internal bond</i>	EN 319	≥ 1,2 N/mm ²

AŞINMA SINIFLARI/ABRASION CLASSES

PRUVA	Az / Low			Yoğun / High		
	21	22	23	31	32	33
	AC1	AC2	AC3	AC4	AC5	
Ortalama aşınma değeri / Average abrasion value	> 900	>1500	>2000	>4000	>6000	

Renkler basılı ve dijital kataloğlarda farklılık gösterebilir. Lütfen, satış noktalarımızda bulunan gerçek ürünler ile karşılaştırınız.

Colors may vary in digital and printed catalogs. Please compare with the actual products in the sales points.



8 MM
FLOORING
PARKE

LUNA





Estetik ve dayanıklılığın uyumu!

Luna Serisi, estetik ve dayanıklılığı mükemmel bir uyum içinde sunarak, doğanın ruhunu yaşam alanlarınıza taşır ve sizi bir doğa harikasını keşfe çıkarır.

The harmony of aesthetics and durability!

The Luna Series offers a perfect harmony of aesthetics and durability, infusing your living spaces with the essence of nature and taking you on an exploration of a natural wonder.



En Width	Boy Length	Kalınlık Thickness	Paket kg Package kg	Paket m ² Package m ²
191 mm	1200 mm	8 mm	~16,50	~2,292

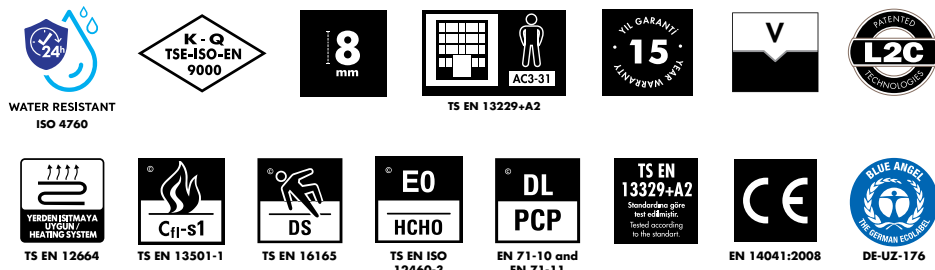















Kalınlık $\pm 0,30$ mm deęişiklik gösterebilmektedir.

Thickness can vary by ± 0.30 mm.

LUNA DEKORLAR

LUNA DECORS

YENİ
KOLEKSİYON
NEW
COLLECTION

 	vera PRK114
 	kamelya camellia PRK111
 	lotus PRK112
 	yuka yucca PRK113
	anemon anemone PRK102
	vegas PRK104
	verona PRK1110
	akasya acacia PRK103
	frezya freesia PRK105
	gardenya gardenia PRK109

Dekor renkleri ile uyumlu zengin renk alternatiflerine sahip süpürgelik çeşitleri bulunmaktadır.

There are skirting options and rich color alternatives that match the decor colors.

veni new

vera



Luna



İspanya'nın Vera bölgesinden alınan ilhamla tasarlanan Vera, sıcak ve doğal renkleriyle yaz akşamlarını mekanınıza getirsin. Vera'nın mekanlarınıza kattığı zarafet ve rustik dokuyla, her adımda ferahlık ve estetiği hissedin.

Inspired by the Vera region of Spain, Vera brings summer evenings to your space with its warm and natural colors.

Feel the freshness and aesthetics at every step with the elegance and rustic texture Vera adds to your spaces.

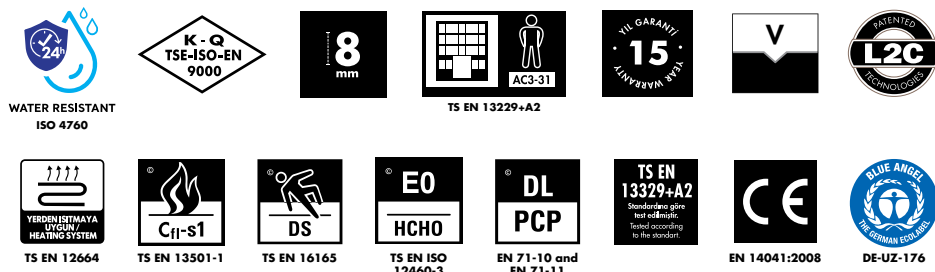

yeni new

kamelya
camellia

Luna

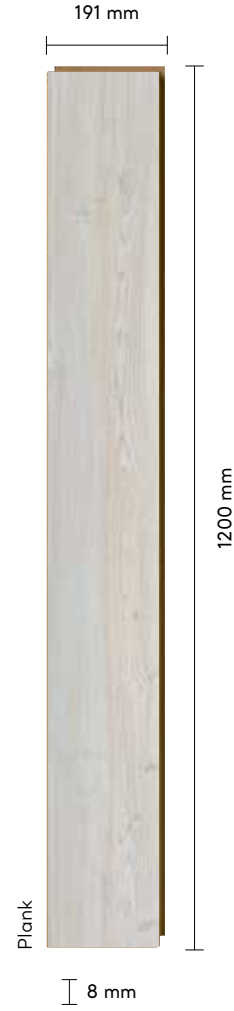

Japonya'nın incelik dolu atmosferini mekanlarınıza taşıyın!
Kamelya çiçeği, mekanlarınızda da bir öykü oluştursun.
Bu eşsiz çiçeğin çekiciliği, iç mekanlarınızı büyüleyici bir aura ile doldursun.

*Bring the subtle atmosphere of Japan to your spaces!
Let the camellia flower create a story in your spaces.
Let the allure of this unique flower fill your interiors with an enchanting aura.*

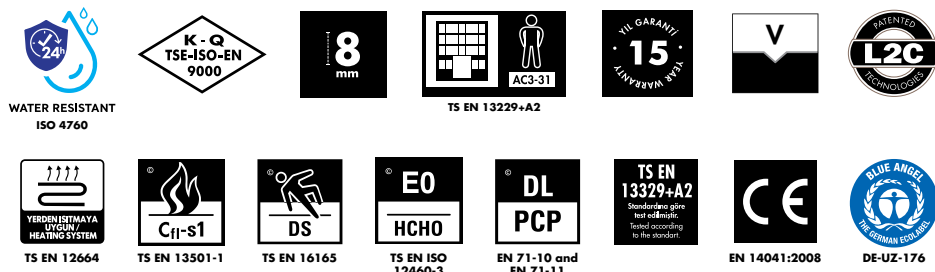



yeni new

lotus

Luna

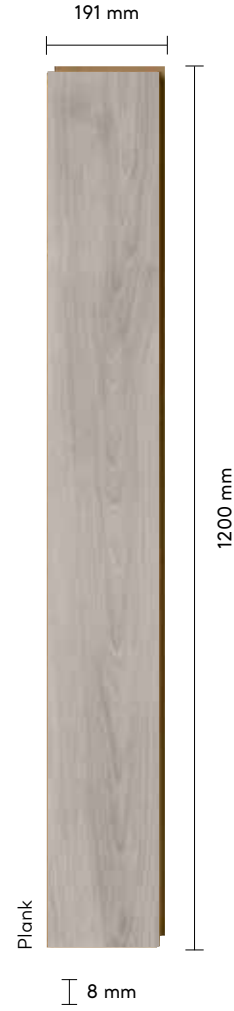

Dönüşüm zamanı gelmedi mi?
Lotus çiçeği, içsel değişimin
sembolüdür.
Lotus serisiyle, mekanlarınızı
dönüştürün ve ruhunuzu besleyin.

*Isn't it time to embrace
transformation?
The lotus flower is a symbol of inner
change.
Transform your spaces and nourish
your soul with the Lotus series.*

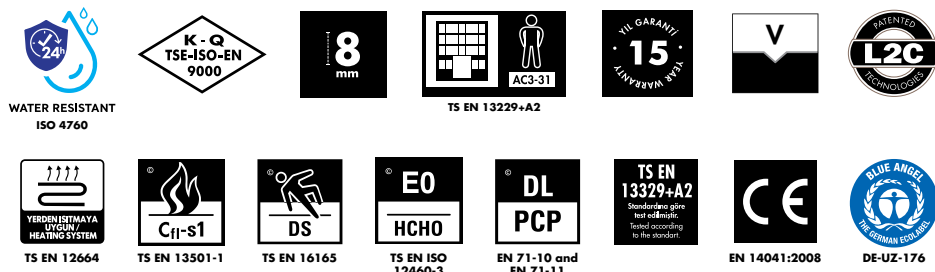

yeni new

yuka

yucca

Luna

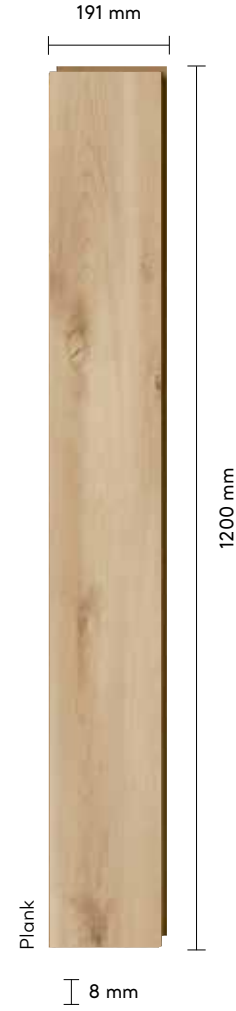

Doğanın incisi Yucca'yla yaşamaya hazır mısınız?

Yucca, sadece zarif bir estetik sunmakla kalmıyor, aynı zamanda beyaz veya krem renkli çiçeklerle dikkat çekiyor. Yucca dekoruyla, mekânlarınızda eşsiz bir büyü ve zarafet atmosferi oluşturun.

Are you ready to live with Yucca, the pearl of nature?

Yucca not only offers an elegant aesthetic but also captivates with its white or cream-colored flowers.

Enrich your spaces with a unique atmosphere of magic and elegance with the Yucca decors.

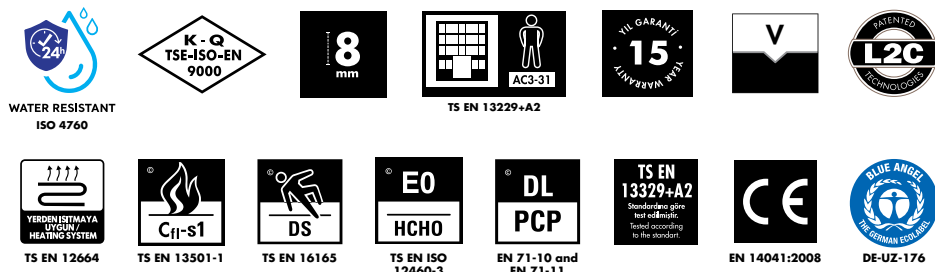

anemon
anemone

Luna



Akdeniz sahillerinin neşesini ve ferahlığını yaşam alanlarınıza taşıyın. Mekanınıza doğal bir zarafet ve canlılık katın.

Bring the joy and freshness of the Mediterranean coast to your living spaces. Add a natural elegance and vitality to your space.

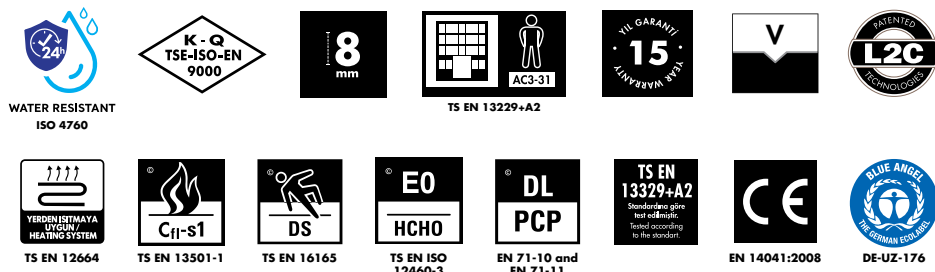



vegas

Luna

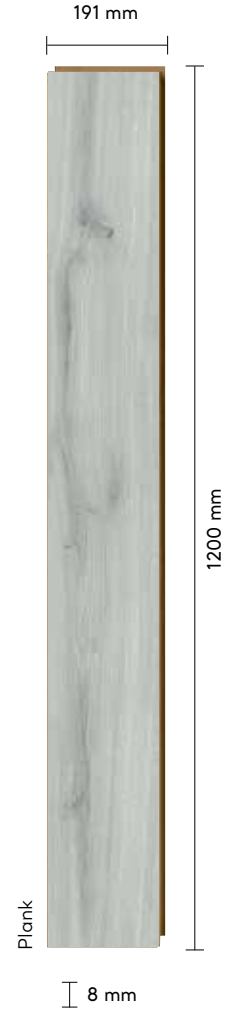

Vegas ile yeniliğin rüzgârını yaşam alanlarınızda essin. Mekânınıza modern ve enerjik bir dokunuş katın.

Let the wind of innovation blow in your living spaces with Vegas. Add a modern and energetic touch to your space.

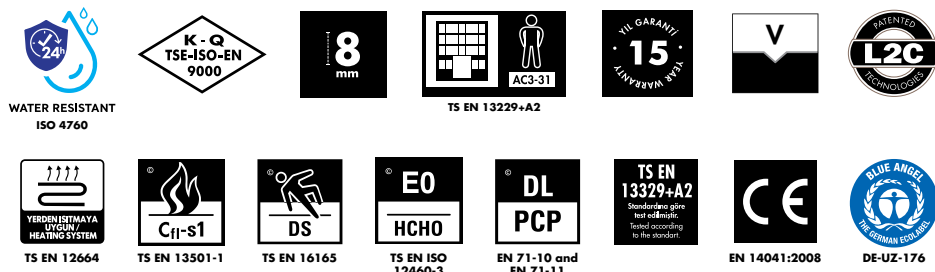

verona

Luna



Verona'nın gri-beyaz tonları ile mekanınıza minimalist ve modern bir dokunuş katın. Her anı sanat eseri gibi yaşayın.

Give your space a minimalist and modern touch with Verona's gray-white tones. Live every moment like a work of art.

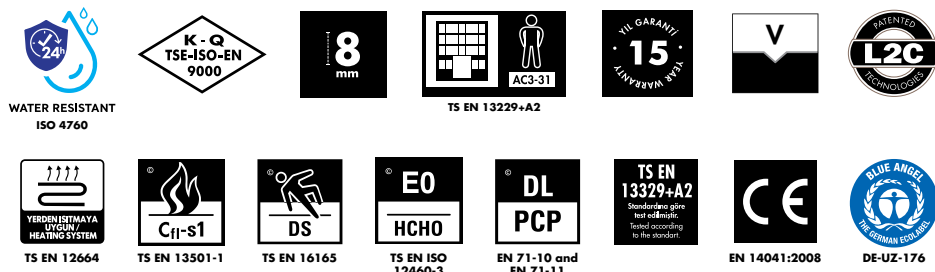



akasya
acacia

Luna



Toprak tonlarında doğal dokunuşla mekânınıza doğal bir sıcaklık ve huzur katın.
Yaşam alanlarınızı sakin ve davetkâr hale getirin.

*Add natural warmth and tranquility to your space with a natural touch in earth tones.
Make your living spaces calm and inviting.*

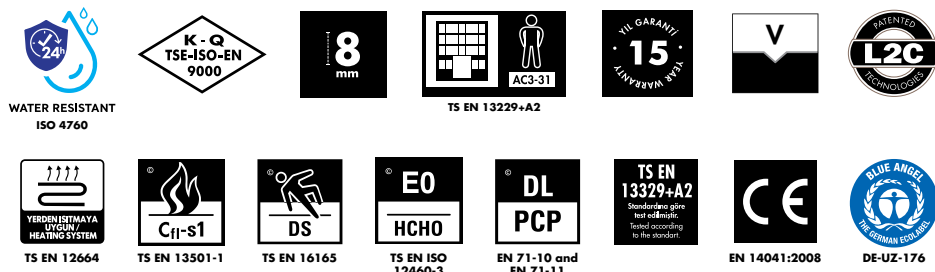

frezya
freesia



Luna

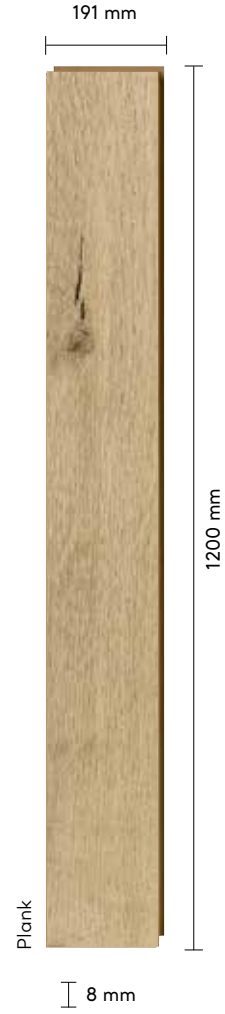

Frezya çiçeğinin esintisini evinize taşıyın.

Doğanın tazeliğini yaşam alanlarınıza yansıtarak içsel huzurunuzu ve ferahlığınızı her an koruyun.

*Bring the breeze of the freesia flower to your home.
Protect your inner peace and freshness at all times by reflecting the freshness of nature to your living spaces.*

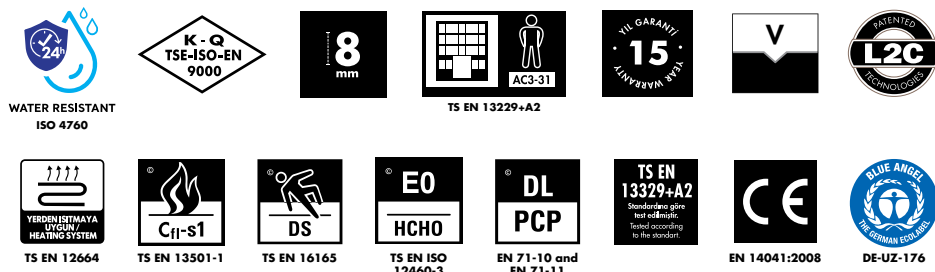



gardenya
gardenia

Luna

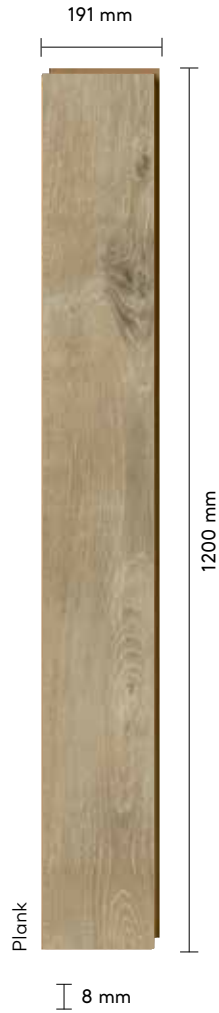

Benzersiz desenleri ve sıra dışı dokusuyla mekânınıza çağdaş bir zarafet katan şıklığı keşfedin! Yaşam alanlarınıza zarif detaylar ekleyin, estetiği hissedin.

*Discover the aesthetic that adds a contemporary elegance to your space with its unique patterns and extraordinary texture!
Add elegant details to your living spaces and feel the aesthetics.*

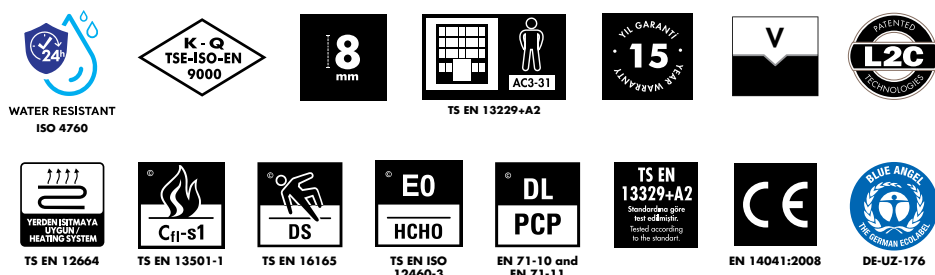

LUNA TEKNİK ÖZELLİKLER LUNA TECHNICAL SPECIFICATIONS

ÖZELLİKLER / SPECIFICATIONS	STANDART / STANDARD	SONUÇLAR / RESULTS
Elementler arası kalınlık farkı <i>Thickness difference between elements</i>	EN 13329	T ortalama < 0,50 mm t max-t min < 0,50 mm T average < 0,50 mm t max-t min < 0,50 mm
Elementin baş kısmı gönye sapması <i>Deviation from squareness of element</i>	EN 13329	Q max < 0,2mm
Yüzey tabakasının uzunluğu <i>Length tolerance</i>	EN 13329	l < 1500mm l fark < 0,5mm l < 1500mm l difference < 0,5mm
Yüzey tabakasının genişliği <i>Width tolerance</i>	EN 13329	W ortalama fark 0,10mm w max- w min < 0,20mm W average difference 0,10mm w max- w min < 0,20mm
Kılıcına dönme miktarı <i>Edgewise bending</i>	EN 13329	0,30 mm
Elementin yüzey düzgünlüğü <i>Element's surface smoothness</i>	EN 13329	Fw içbükey < %0,15 fw dışbükey < %0,20 F1 içbükey < %0,50 fl dışbükey < %1,00 Fw concave < %0,15 fw convex < %0,20 F1 concave < %0,50 fl convex < %1,00
Elementler arası açıklık <i>Space between elements</i>	EN 13329	O ortalama < 0,15mm o en büyük 0,15mm O average < 0,15mm o max 0,15mm
Elementler arası yükseklik farkı <i>Height difference between elements</i>	EN 13329	H ortalama < 0,10mm H max < 0,15mm H average < 0,10mm H max < 0,15mm
Yüzey sağlamlığı <i>Surface soundness</i>	EN 13329	AC3 ≥ 1.0 N/mm ²
Işık haslığı <i>Light fastness</i>	EN ISO 4892 - 2:200	EN 20105 - A02'ye göre gri ölçekte ≥ 4 maruz kalmayan ve maruz kalan örnek parça arasındaki renk kontrastı Colour contrast between unexposed and exposed sample part ≥ 4 of grey scale according to EN 20105 - A02
Çarpma mukavemeti <i>Impact resistance</i>	EN 13329	23. ve 31. sınıf için IC1 IC1 for 23rd and 31th class
Koltuk tekerleği etkisi <i>Determination of the effect of a castor chair</i>	EN 425	Görünümde bir değişiklik veya zarar olmayacak No change or damage on appearance should occur
Mobilya ayağı etkisi <i>Determination of the effect of a castor furniture</i>	EN 424	Görülebilir zarar olmamalıdır. No visible damage should occur
Sıcak kaplara dayanıklılık <i>Resistance to hot pots</i>	EN 13329	Sınıf 4 / Class 4
Su buharına karşı dayanıklılık <i>Resistance to water vapor</i>	EN 13329	Sınıf 4 / Class 4
Leke tutmaya karşı dayanıklılık <i>Stain resistance</i>	EN 13329	Sınıf 5 / Class 5
24 saat suda şişme <i>24 hours swelling in thickness</i>	EN 13329	< %18
Yoğunluk <i>Density</i>	EN 323	AGT'ye özgü/Specific to AGT
Eğilme dayanımı <i>Bending strenght</i>	EN 317	850-900 kg/mm ³
Elastikiyet modülü <i>Modulus of elasticity</i>	EN 310	> 3500 N/mm ²
Çekme dayanımı <i>Vertical internal bond</i>	EN 319	> 1,2 N/mm ²
Çizilme mukavemeti (N) <i>Scratch resistance</i>	EN 438	> 3,5
Aşınma dayanımı <i>Abrasion Resistance</i>	EN 438	Devir / Cycle ≥ 2000

AŞINMA SINIFLARI/ABRASION CLASSES

LUNA

Az / Low

Yoğun / High

21

22

23

31

32

33

AC1

AC2

AC3

AC4

AC5

Ortalama aşınma değeri / Average abrasion value

>2000

Renkler basılı ve dijital kataloglarda farklılık gösterebilir. Lütfen, satış noktalarımızda bulunan gerçek ürünler ile karşılaştırınız.

Colors may vary in digital and printed catalogs. Please compare with the actual products in the sales points.



8 MM
FLOORING
PARKE

NATURA

SELECT





Yeni bir yaşam, yeni bir doğa.

Doğanın büyülü dünyasından özenle seçilen
Natura Select Parke Serisi ile yaşam alanlarınıza
yenilik katın.

A new life, a new nature.

*Add innovation to your living spaces with the
Natura Select Flooring Series which selected
carefully from the magical side of nature.*

natura select



En Width	Boy Length	Kalınlık Thickness	Paket kg Package kg	Paket m ² Package m ²
191 mm	1200 mm	8 mm	~13,20	~1,8336

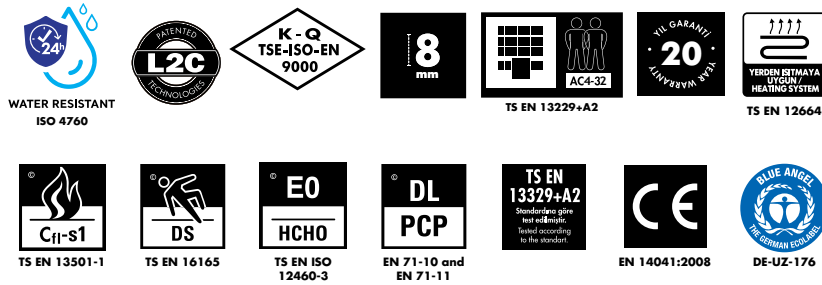

Kalınlık ± 0,30 mm değişiklik gösterebilmektedir.

Thickness can vary by ±0.30 mm.

NATURA SELECT DEKORLAR

NATURA SELECT DECORS

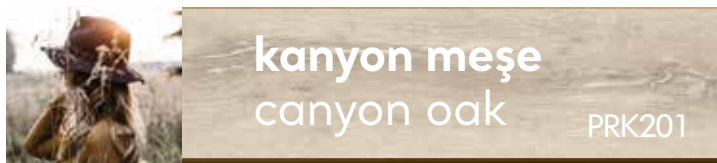
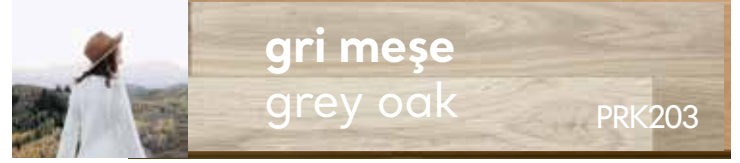
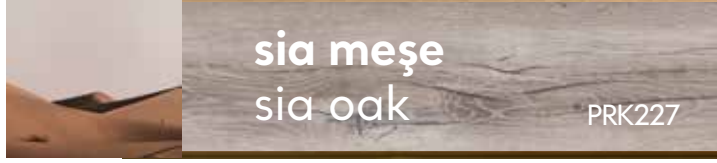
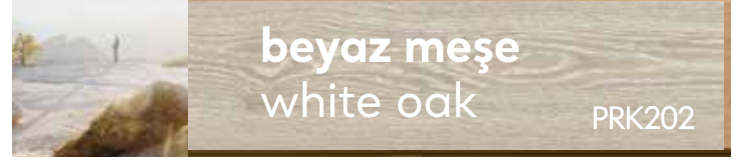

Dekor renkleri ile uyumlu zengin renk alternatiflerine sahip süpürgelik çeşitleri bulunmaktadır.

There are skirting options and rich color alternatives that match the decor colors.



veni new

termessos



Antik kentte büyüleyici bir yürüyüş!
Antik kent Termessos'un muhteşem manzarasını, dokusunu, renklerini ve atmosferini evinizin her yerinde yaşayın.

*Take a mesmerizing walk through the ancient city!
Experience the magnificent view, texture, colors, and atmosphere of the ancient city of Termessos in every part of your home.*

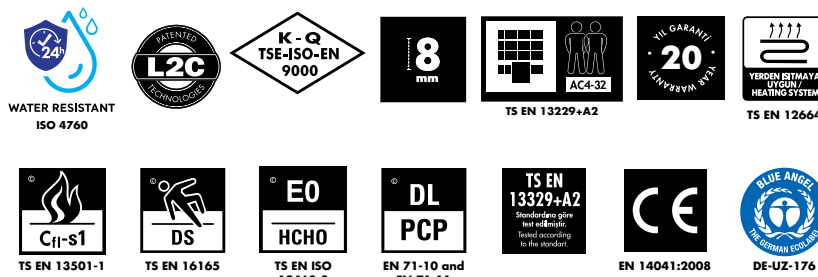

yeni new
teos



Antik dönemin izleri evinizde!
Teos Antik Kenti'nden ilham alan seriyle hayran kalınan ortamlar yaratın.

*Bring the traces of the ancient era into your home!
Create environments that will be admired with the series inspired by the ancient city of Teos.*

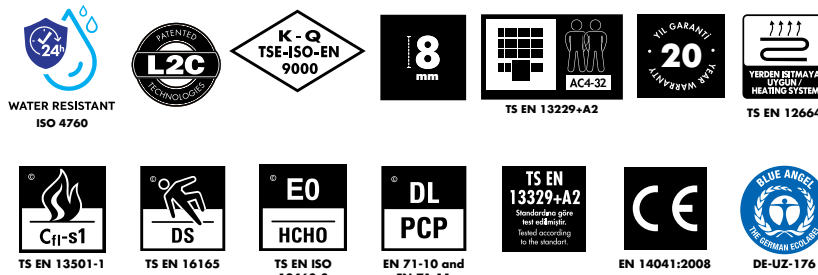

sia meşe
sia oak



Doğanın eşsiz güzelliği ve sakinliğin özenli dokusu evinize doğal bir hava katsın.

Let the unique beauty of nature and the elaborate texture of calmness add a natural atmosphere to your home.



porto



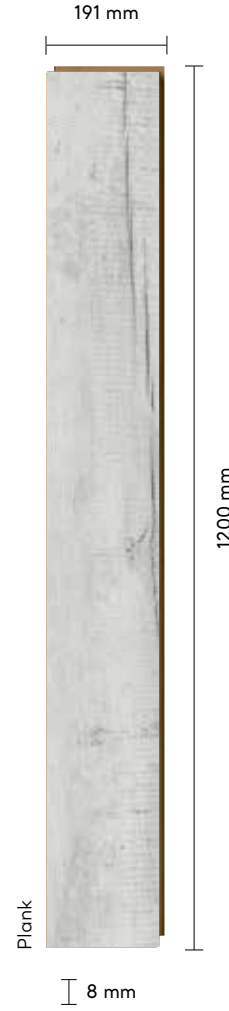

Asil liman kentlerinin iç açan ferahlığı!
Doğal damarlara sahip gri tonlarla
mekanınızın havasını değiştirin.

*Hearth-warming refreshment
of noble port cities!
Change the mood of your space with
shades of gray that has natural veins.*



TS EN 13501-1



TS EN 16165



TS EN ISO
12460-3



EN 71-10 and
EN 71-11



Standartlara göre
test edilmiş
Ticari olarak
TSE tarafından



EN 14041:2008



DE-UZ-176



patara

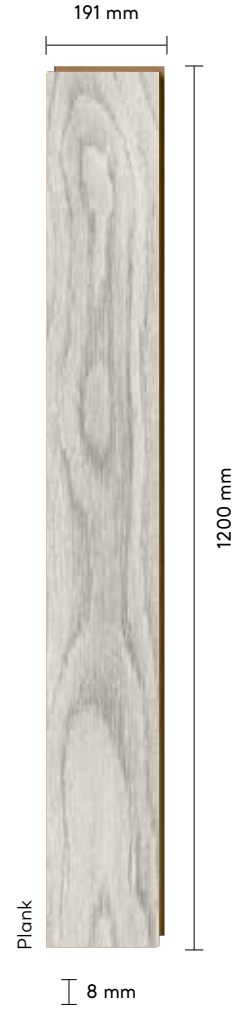

Antik kentlerden doğan güzellik!
Beyaza çalan kumların ferahlatan
esintilerini mekanınızda yakalayın.

*Beauty that born from ancient cities!
Have the refreshing breezes of
white sands in your living spaces.*



TS EN 13501-1



TS EN 16165



TS EN ISO
12460-3



EN 71-10 and
EN 71-11



Standartlara göre
test edilmiş
test edilmiş
test edilmiş



EN 14041:2008



DE-UZ-176

antalya çam
antalya pine



Doğallık trendine yeni bir soluk!
Çamın keskin çizgilerini ve Antalya'nın doğal güzelliğini mekanınıza taşıyın.

*A new breathtaking natural decor.
Bring the sharp lines of pine and the natural beauty of Antalya city to your place.*



TS EN 13501-1

TS EN 16165

TS EN ISO 12460-3

EN 71-10 and EN 71-11

Standartlara göre test edilmiş, test edilmiş olduğuna göre standart.

EN 14041:2008

DE-UZ-176

kemer çam
kemer pine



Antalya'nın cennet köşesinden doğal ve estetik bir dokunuş!
Kemer'in doğasının izleriyle mekanınıza yeni bir esinti katın.

*A natural touch from the paradise corner of Antalya!
Bring a fresh breeze to your living spaces with traces of Kemer's unique nature.*

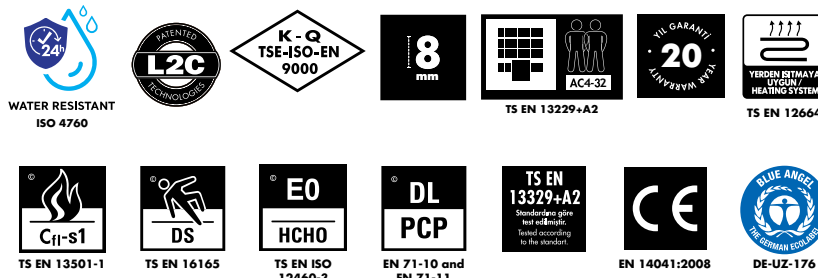

kanyon meşe
canyon oak



Yıllara meydan okuyan güç! Toprağın yalın ve eşsiz renk tonlarıyla meşenin kıvrımlı formunu mekanınızda yakalayın.

*A power that defies years!
Have the curved atmosphere
of oak in your space with the lean and
unique hues of the soil.*

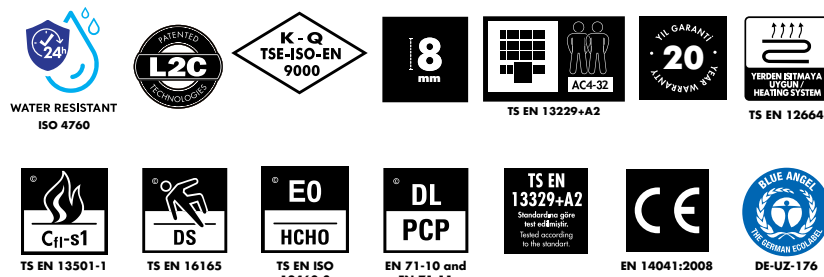

pasifik am
pacific pine

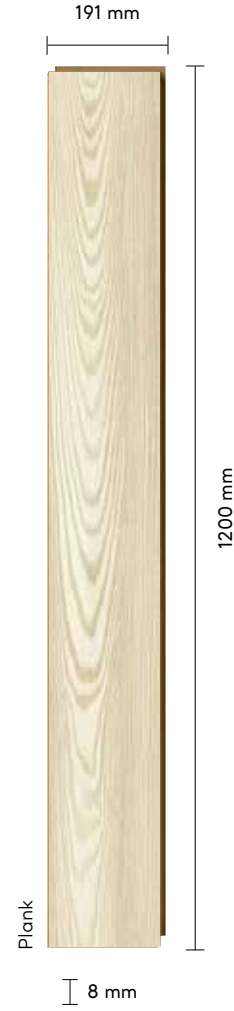

Pasifik Okyanusu'nun suladığı topraklardan eşsiz bir parça! Benzersiz dekoru ve özgün çizgileriyle yaşam alanlarınıza taze bir enerji katın.

*A unique piece of land irrigated by the Pacific Ocean!
Add fresh energy to your living spaces with its authentic decor and original lines.*

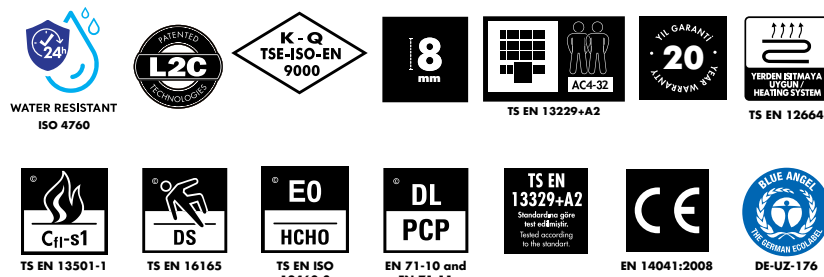

beyaz meşe
white oak



Değerini kaybetmeyen bir ikon!
Beyazın asiliği ve meşenin doğallığıyla
mekanınızın atmosferini değiştirin.

*An icon that isn't lose its value!
Change the atmosphere of your place
with the rebelliousness of white
and the naturalness of oak.*



gri meşe
grey oak



Daima genç, daima yeni! Ölümsüzlüğün ve gençliğin sembolü olan meşe ağacının kendini yenileyen formunu mekanınızda hissedin.

*Always young, always new!
Feel the renewed form of the oak tree, a symbol of immortality and youth, in your space.*



silyon meşe
silyon oak



Antik Yunan'dan günümüze bir miras!
Meşe ağacının beyaz ve kahve tonlarının
harmanıyla mekanınızı yenileyin.

*A legacy from Ancient Greece!
Renew your space with blend of
oak white and brown tones.*



TS EN 13501-1



TS EN 16165



TS EN ISO
12460-3



EN 71-10 and
EN 71-11



Standartına göre
test edilmiş
farklı standartlara
göre test edilmiştir



EN 14041:2008



DE-UZ-176

şiraz meşe
shiraz oak



Sanatsal bir zenginlik!
Pers İmparatorluğu'nun kültür başkenti Şiraz kentinin izlerini yaşam alanlarınıza konuk edin.

*An artistic wealth!
Welcome the traces and beauty of the city of Shiraz, the cultural capital of the Persian Empire, to your living spaces.*





patricia



İtalya'nın doğal güzelliği evinle buluşsun!
Doğadan alınan eşsiz ilhamla üretilen
dekorla yaşamın huzur dolsun.

*Let the natural beauty of Italy meet with
your home! Let your life be full of peace
with the decor produced with the unique
inspiration of nature.*



WATER RESISTANT
ISO 4760

L2C
TECHNOLOGIES

K-Q
TSE-ISO-EN
9000

8
mm

TS EN 13329+A2

20
YIL GARANTİ

YERDEN İSTİTİMAYA
HEATING SYSTEM
TS EN 12664

TS EN 13501-1

TS EN 16165

TS EN ISO
12460-3

EN 71-10 and
EN 71-11

Standartlara göre
test edilmiş
faydalıdır.

EN 14041:2008

DE-UZ-176

natura meşe
natura oak

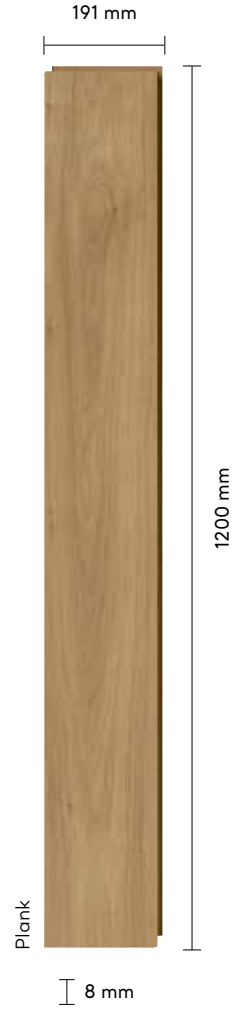

Sıcak, samimi ve cömert bir doku!
Doğanın cömertliğini keşfedin ve
yaşam alanlarınıza taşıyın.

*Warm, friendly and generous texture!
Discover the generosity of nature
and bring it into your living spaces.*



olimpus meşe
olympus oak



Günümüze ulaşan efsane!
Toros Dağları'nın muhteşem tonlarıyla mekanınıza canlılık ve sıcaklık getirin.

*A legend that has reached today!
Bring vitality and warmth to your place with the gorgeous patterns Taurus Mountains.*

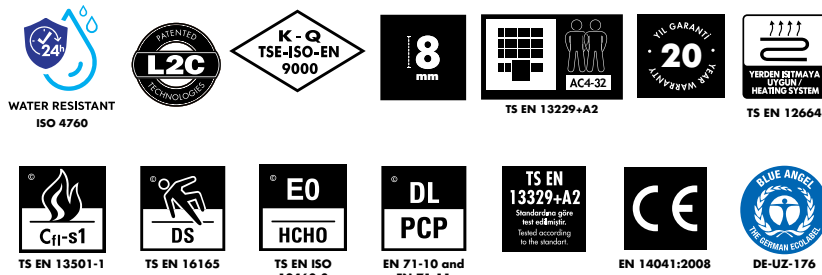

NATURA SELECT TEKNİK ÖZELLİKLER NATURA SELECT TECHNICAL SPECIFICATIONS

ÖZELLİKLER / SPECIFICATIONS	STANDART / STANDARD	SONUÇLAR / RESULTS
Elementler arası kalınlık farkı <i>Thickness difference between elements</i>	EN 13329	T ortalama < 0,50 mm t max-t min < 0,50 mm T average < 0,50 mm t max-t min < 0,50 mm
Aşınma dayanımı <i>Abrasion Resistance</i>	EN 438	Devir > 4000 Cycle > 4000
Elementin baş kısmı gönye sapması <i>Deviation from squareness of element</i>	EN 13329	Q max < 0,2mm
Yüzey tabakasının uzunluğu <i>Length tolerance</i>	EN 13329	l < 1500mm l fark < 0,5mm l < 1500mm l difference < 0,5mm
Yüzey tabakasının genişliği <i>Width tolerance</i>	EN 13329	W ortalama fark 0,10mm w max- w min < 0,20mm W average difference 0,10mm w max- w min < 0,20mm
Kılıcına dönme miktarı <i>Edgewise bending</i>	EN 13329	0,30 mm
Elementin yüzey düzgünlüğü <i>Element's surface smoothness</i>	EN 13329	Fw içbükey < %0,15 fw dışbükey < %0,20 F1 içbükey < %0,50 fl dışbükey < %1,00 Fw concave < %0,15 fw convex < %0,20 F1 concave < %0,50 fl convex < %1,00
Elementler arası açıklık <i>Space between elements</i>	EN 13329	O ortalama < 0,15mm o max 0,15mm O average < 0,15mm o max 0,15mm
Elementler arası yükseklik farkı <i>Height difference between elements</i>	EN 13329	H ortalama < 0,10mm H max < 0,15mm H average < 0,10mm H max < 0,15mm
Yüzey sağlamlığı <i>Surface soundness</i>	EN 13329	AC4 ≥ 1,25 N/mm ²
Çizilme mukavemeti (N) <i>Scratch resistance</i>	EN 438	> 3,5
Işık haslığı <i>Light fastness</i>	EN ISO 4892 - 2:200	EN 20105 - A02'ye göre gri ölçekte ≥ 4 maruz kalmayan ve maruz kalan örnek parça arasındaki renk kontrastı Colour contrast between unexposed and exposed sample part ≥ 4 of grey scale according to EN 20105 - A02
Çarpma mukavemeti <i>Impact resistance</i>	EN 13329	32. sınıf için IC2 IC2 for 32 th class
Koltuk tekerleği etkisi <i>Determination of the effect of a castor chair</i>	EN 425	Görünümde bir değişiklik veya zarar olmayacak No change or damage on appearance should occur
Mobilya ayağı etkisi <i>Determination of the effect of a castor furniture</i>	EN 424	Görülebilir zarar olmamalıdır. No visible damage should occur
Sıcak kaplara dayanıklılık <i>Resistance to hot pots</i>	EN 13329	Sınıf 4 / Class 4
Su buharına karşı dayanıklılık <i>Resistance to water vapor</i>	EN 13329	Sınıf 4 / Class 4
Leke tutmaya karşı dayanıklılık <i>Stain resistance</i>	EN 13329	Sınıf 5 / Class 5
24 saat suda şişme <i>24 hours swelling in thickness</i>	EN 13329	< %18
Yoğunluk <i>Density</i>	EN 323	AGT'ye özgü/Specific to AGT
Eğilme dayanımı <i>Bending strenght</i>	EN 317	40 N/mm ²
Elastikiyet modülü <i>Modulus of elasticity</i>	EN 310	3500 N/mm ²
Çekme dayanımı <i>Vertical internal bond</i>	EN 319	≥ 1,2 N/mm ²

AŞINMA SINIFLARI/ABRASION CLASSES

	Az / Low				Yoğun / High	
NATURA SELECT	21	22	23	31	32	33
	AC1	AC2	AC3		AC4	AC5
Ortalama aşınma değeri / Average abrasion value	> 900	>1500	>2000		>4000	>6000

Renkler basılı ve dijital kataloğlarda farklılık gösterebilir. Lütfen, satış noktalarımızda bulunan gerçek ürünler ile karşılaştırınız.

Colors may vary in digital and printed catalogs. Please compare with the actual products in the sales points.



8 MM
FLOORING
PARKE

BELLA NEO





Küçük detaylardaki büyük yenilik!

Bazen, bir çiçek gibi ufacık bir detay bile ortamın havasını kolayca değiştirir. Bella Neo Parke Serisi'nin yeni doğal yüzeyi ile yaşam alanlarınızı kolayca yenileyin.

Great innovation in small details!

Sometimes, even the smallest detail like a flower, easily changes the mood of the environment. With the new natural surface of Bella Neo Flooring Series Easily refresh your living spaces.

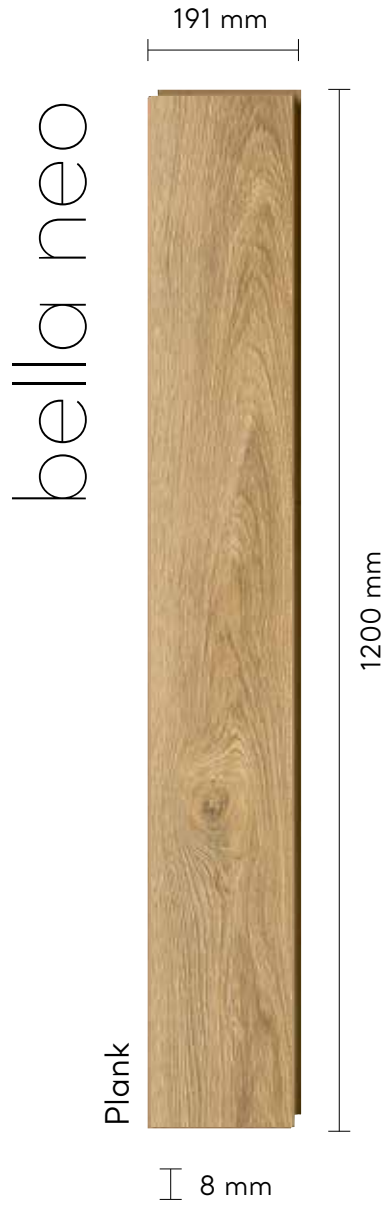

En Width	Boy Length	Kalınlık Thickness	Paket kg Package kg	Paket m ² Package m ²
191 mm	1200 mm	8 mm	~16,50	~2,292

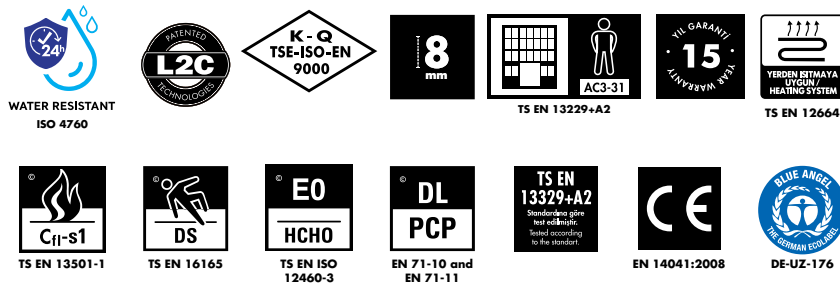

Kalınlık ± 0,30 mm değişiklik gösterebilmektedir.

Thickness can vary by ±0.30 mm.

BELLA NEO DEKORLAR

BELLA NEO DECORS

Yeni
New

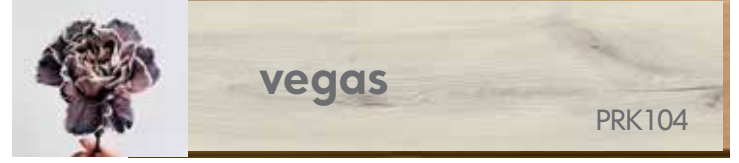

Yeni
New



Yeni
New



Yeni
New

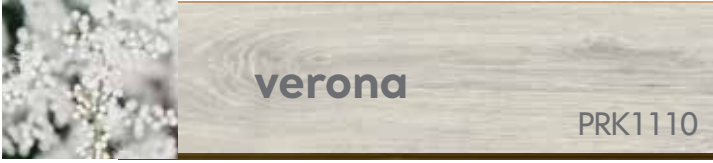

Dekor renkleri ile uyumlu zengin renk alternatiflerine sahip süpürgelik çeşitleri bulunmaktadır.

There are skirting options and rich color alternatives that match the decor colors.



veni new

vera



Vera ile zamansız bir doğallığa!
İspanya'nın Vera Bölgesi'ndeki kumsalların renk tonlarını seçin, her adımda zamanın ötesine geçin.

Experience timeless natural beauty with Vera!
Choose the hues of the beaches in Spain's Vera Region, transcend time with every step.



yeni new

kamelya
camellia

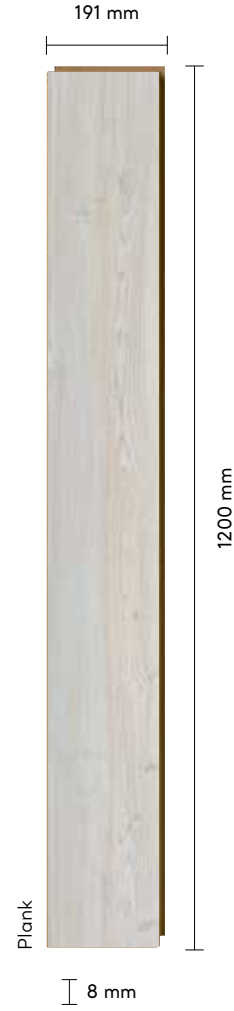

Mekanlarınıza Japonya'nın eşsiz zarafetini katın!

Tsubaki çiçeği olarak da bilinen, samurayların erdemlerini temsil eden Kamelya'nın gücü ve zarafeti mekanlarınızda filizlensin.

Add the unique elegance of Japan to your spaces!

Let the strength and elegance of the Camellia, also known as the Tsubaki flower and representative of the virtues of samurais, blossom in your spaces.

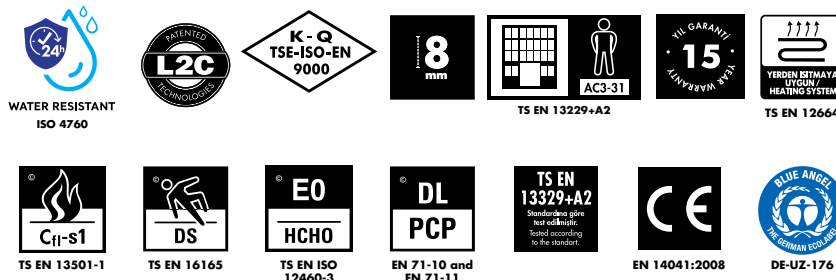



yeni new

lotus

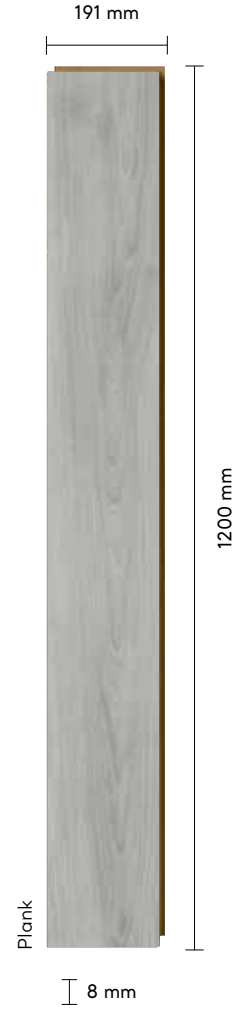

Mekânlerinizi dönüştürmeye hazır mısınız?
Lotus çiçeği dönüşümün ve ruhsal arınmanın simgesidir. Lotus serisiyle her güne yeniden doğmuş gibi başlayın.

*Are you ready to transform your spaces?
The lotus flower is a symbol of transformation and spiritual purification. Start every day anew with the Lotus series.*



yeni new

yuka

yucca

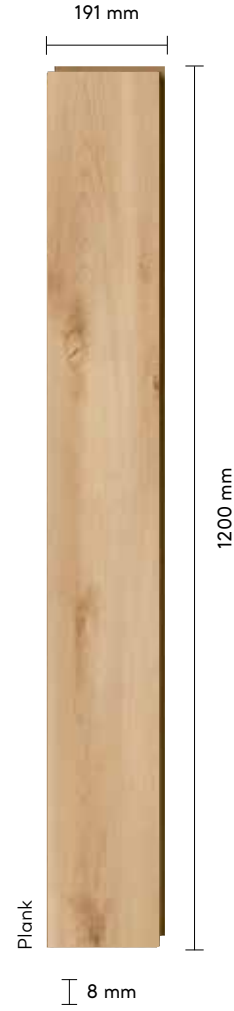

Doğanın incisi Yucca'yı keşfedin!
Yucca, zarif bir görünüm sunarken, tepesinde açan beyaz veya krem renkli çiçekleriyle de göz kamaştırır. Yucca dekoruyla göz kamaştıran ortamlar oluşturun.

*Discover the pearl of nature, Yucca!
Yucca dazzles with its elegant appearance and white or cream-colored flowers blooming at its top. Create stunning environments with the Yucca decors.*



verona





Romeo ve Juliet'in ölümsüz aşkının kentinden bir kesit! Verona Arena'nın gri beyaz tonlarıyla mekanınızda aşka yer açın.

A piece from the city of Romeo and Juliet's immortal love! Make room for love in your place with the grey and white tones of Verona Arena.





manolya
magnolia



Asaletin benzersiz tonları!
Benzersiz kokusuyla akıllarda
iz bırakan manolyanın güzel
enerjisini mekanınıza taşıyın.

*Unique shades of nobility!
Bring your place the beautiful
energy of magnolia, which
leaves effect on the minds
with its unique smell.*





lilyum
lilies

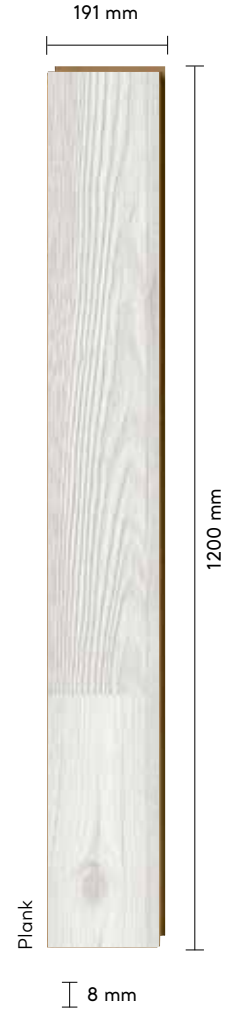

Büyük deęişimlerin sırrı,
küçük detaylarda saklıdır!
Baharın taze esintileriyle
mekanınızın havasını deęiştirin.

*The secret of big changes
is hidden in small details!
Easily change the mood
of your place with
the fresh breezes of spring.*





vegas

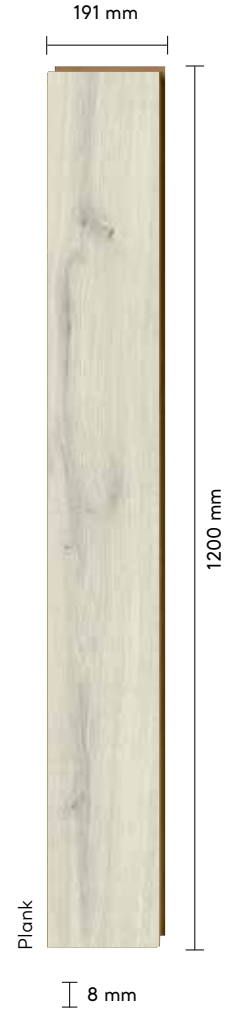

Ferah ve dalgalı!
Saf ihtişama sahip dekoruyla
yaşam alanlarındaki yeniliği
gözler önüne serin.

*Spacious and wavy!
Reveals the innovation
in your spaces with its decor
that has pure splendor.*





anemon
anemone

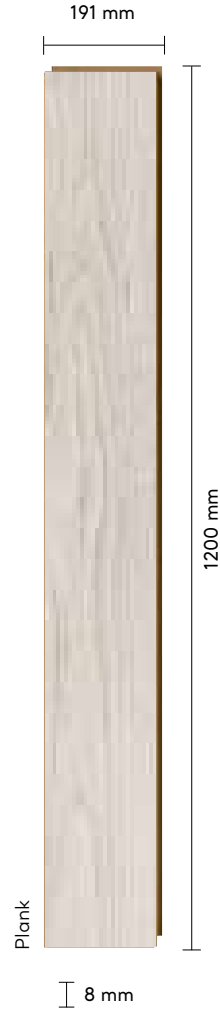

Aradığınız huzur mekanınızda!
Akdeniz sahillerinin huzuru ve mutluluğunu mekanınıza taşıyın.

*The peace you seek is in your place!
Bring your place peace and happiness of
the Mediterranean coast.*





akasya
acacia



Sıcak, samimi ve doğal!
Toprak tonlarının narin ve belirgin çizgileriyle mekanınızda doğayı keşfedin.

*Warm, friendly and natural!
Discover natural vibes in your space with delicate and distinctive lines of earth tones.*



frezya
freesia

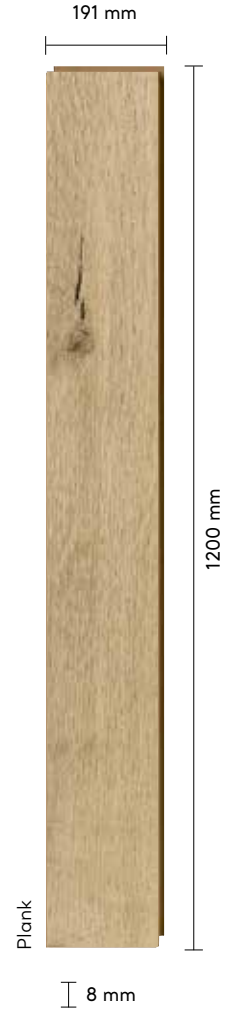

Enerjik ve sıcak!
Doğanın narin dokusundan izlerle yaşam alanlarınızın atmosferini değiştirin.

*Energetic and warm!
Change the atmosphere of your spaces with traces of nature's delicate texture.*





gardenya
gardenia



Zarafete yer açın!
Sıcak ve aydınlık dekoruyla
yaşam alanlarınıza
narin dokunuşlar ekleyin.

*Make room for grace!
Add delicate touches to
your living spaces with
its warm and bright decor.*

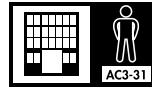

TS EN 13501-1



TS EN 16165



TS EN ISO 12460-3



EN 71-10 and EN 71-11



Standartına göre test edilmiştir. Test edilmiştir. Tested according to the standard.



EN 14041:2008



DE-UZ-176



defne
daphne

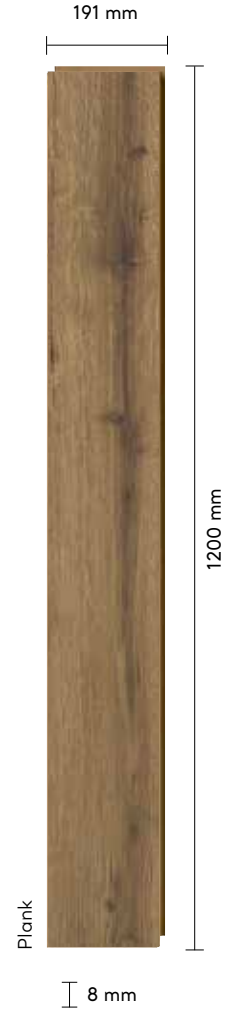

Doğayla yakınlaşma zamanı!
Doğanın sunduğu benzersiz tonları
mekanınıza yansıtın.

*It's time to get closer to nature!
Reflect the unique and warm
tones of nature at your place.*



BELLA NEO TEKNİK ÖZELLİKLER

BELLA NEO TECHNICAL SPECIFICATIONS

ÖZELLİKLER / SPECIFICATIONS	STANDART / STANDARD	SONUÇLAR / RESULTS
Elementler arası kalınlık farkı <i>Thickness difference between elements</i>	EN 13329	T ortalama < 0,50 mm t max-t min < 0,50 mm T average < 0,50 mm t max-t min < 0,50 mm
Elementin baş kısmı gönye sapması <i>Deviation from squareness of element</i>	EN 13329	Q max < 0,2mm
Yüzey tabakasının uzunluğu <i>Length tolerance</i>	EN 13329	l < 1500mm l fark < 0,5mm l < 1500mm l difference < 0,5mm
Yüzey tabakasının genişliği <i>Width tolerance</i>	EN 13329	W ortalama fark 0,10mm w max- w min < 0,20mm W average difference 0,10mm w max- w min < 0,20mm
Kılıcına dönme miktarı <i>Edgewise bending</i>	EN 13329	0,30 mm
Elementin yüzey düzgünlüğü <i>Element's surface smoothness</i>	EN 13329	Fw içbükey < %0,15 fw dışbükey < %0,20 F1 içbükey < %0,50 fl dışbükey < %1,00 Fw concave < %0,15 fw convex < %0,20 F1 concave < %0,50 fl convex < %1,00
Elementler arası açıklık <i>Space between elements</i>	EN 13329	O ortalama < 0,15mm o en büyük 0,15mm O average < 0,15mm o max 0,15mm
Elementler arası yükseklik farkı <i>Height difference between elements</i>	EN 13329	H ortalama < 0,10mm H max < 0,15mm H average < 0,10mm H max < 0,15mm
Yüzey sağlamlığı <i>Surface soundness</i>	EN 13329	AC3 ≥ 1.0 N/mm ²
Işık haslığı <i>Light fastness</i>	EN ISO 4892 - 2:200	EN 20105 - A02'ye göre gri ölçekte ≥ 4 maruz kalmayan ve maruz kalan örnek parça arasındaki renk kontrastı Colour contrast between unexposed and exposed sample part ≥ 4 of grey scale according to EN 20105 - A02
Çarpma mukavemeti <i>Impact resistance</i>	EN 13329	23. ve 31. sınıf için IC1 IC1 for 23rd and 31th class
Koltuk tekerleği etkisi <i>Determination of the effect of a castor chair</i>	EN 425	Görünümde bir değişiklik veya zarar olmayacak No change or damage on appearance should occur
Mobilya ayağı etkisi <i>Determination of the effect of a castor furniture</i>	EN 424	Görülebilir zarar olmamalıdır. No visible damage should occur
Sıcak kaplara dayanıklılık <i>Resistance to hot pots</i>	EN 13329	Sınıf 4 / Class 4
Su buharına karşı dayanıklılık <i>Resistance to water vapor</i>	EN 13329	Sınıf 4 / Class 4
Leke tutmaya karşı dayanıklılık <i>Stain resistance</i>	EN 13329	Sınıf 5 / Class 5
24 saat suda şişme <i>24 hours swelling in thickness</i>	EN 13329	< %18
Yoğunluk <i>Density</i>	EN 323	AGT'ye özgü/Specific to AGT
Eğilme dayanımı <i>Bending strenght</i>	EN 317	850-900 kg/mm ³
Elastikiyet modülü <i>Modulus of elasticity</i>	EN 310	> 3500 N/mm ²
Çekme dayanımı <i>Vertical internal bond</i>	EN 319	> 1,2 N/mm ²
Çizilme mukavemeti (N) <i>Scratch resistance</i>	EN 438	> 3,5
Aşınma dayanımı <i>Abrasion Resistance</i>	TS EN 438-7	Devir / Cycle ≥ 2000

AŞINMA SINIFLARI/ABRASION CLASSES

	Az / Low			Yoğun / High		
BELLA NEO	21	22	23	31	32	33
	AC1	AC2	AC3	AC4	AC5	
Ortalama aşınma değeri / Average abrasion value	>2000					

Renkler basılı ve dijital kataloğlarda farklılık gösterebilir. Lütfen, satış noktalarımızda bulunan gerçek ürünler ile karşılaştırınız.

Colors may vary in digital and printed catalogs. Please compare with the actual products in the sales points.



7,5 MM
FLOORING
PARKE

CORVINA





Yeni Dünyaları Keşfet!

Yepyeni AGT Corvina Koleksiyonu ile
modern ve sofistike bir görünümün
kapısını aralarken yüzeyde
özgün çizgilerin tarzını keşfedin!

Explore New Worlds!

*Discover the style of original lines on the
surface while opening the door to a
modern and sophisticated look with the
brand new AGT Corvina Collection!*

corvina

191 mm

1200 mm

Plank

7,5 mm

En Width	Boy Length	Kalınlık Thickness	Paket kg Package kg	Paket m ² Package m ²
191 mm	1200 mm	7,5 mm	~14,04	~2,292

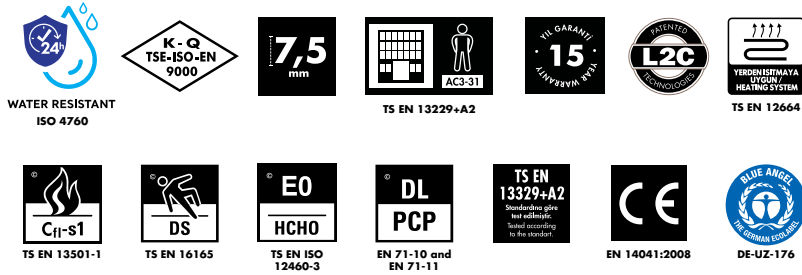

Kalınlık ± 0,30 mm değişiklik gösterebilmektedir.

Thickness can vary by ±0.30 mm.

CORVINA DEKORLAR
CORVINA DECORS



Dekor renkleri ile uyumlu zengin renk alternatiflerine sahip süpürgelik çeşitleri bulunmaktadır.

There are skirting options and rich color alternatives that match the decor colors.



kaleo

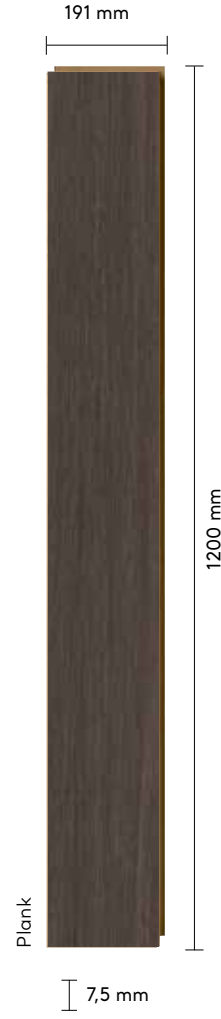

Ruhunuzun iç sesini taşıyarak, her bir köşede estetik detaylarla süslenmiş bir hava yaratan Kaleo, yaşam alanlarınıza eşsiz bir atmosferin ilhamını getirecek.

With the inner voice of your soul, Kaleo brings a unique inspiration to your living spaces, crafting an atmosphere adorned with aesthetic details in every corner.

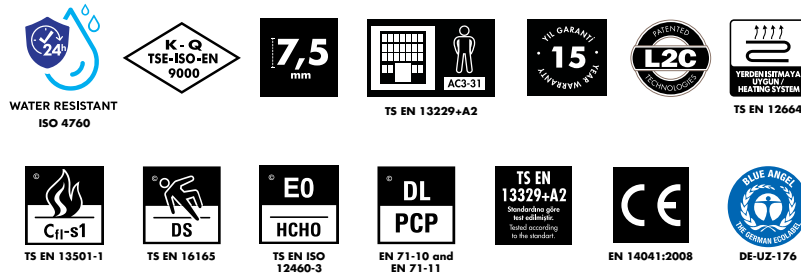



molette



Sonbaharın huzur veren esintisini hissedeceğiniz bir atmosfer sunan Molette ile her dokunuşta ormanda yürüyormuş hissi veren bir enerjiyle tanışın.

Molette offers an atmosphere where you can feel the peaceful breeze of autumn, encountering an energy that evokes the sensation of walking through the forest with every touch.

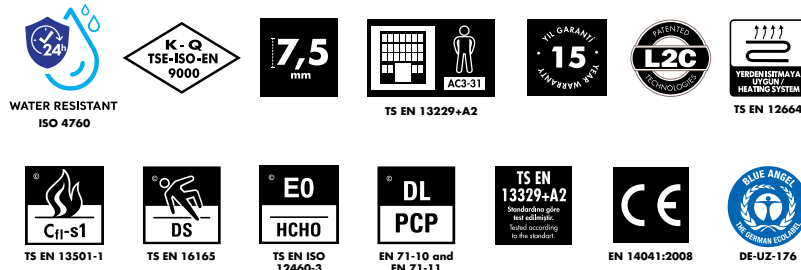



albana



Doğanın güzelliklerini iç mekanınıza taşımak için Albana, doğal uyum ve canlı renkleriyle benzersiz bir seçenek. Albana, yaşam alanlarınıza taze bir nefes ve çekicilik katıyor.

For those seeking to infuse their interiors with nature's beauty, Albana is a unique option where natural harmony and vibrant colors meet. Albana brings a fresh atmosphere and unique charm to your living spaces.

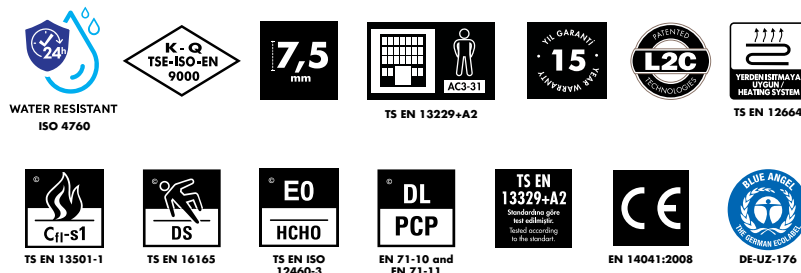



faba



Göz alıcı zarafetiyle her bir detayı titizlikle işleyen Faba ile mekanınıza, zarif bir kuğu gibi kusursuz bir estetik kazandırın. Faba'nın şıklığı ile yaşam alanınızı büyüleyici bir atmosferle doldurup, incelikli detaylarıyla onu hissedin.

Enhance your space with Faba's flawless elegance, crafted meticulously like a swan's grace. Fill your living space with a mesmerizing atmosphere with Faba's elegance and feel it with its subtle details.

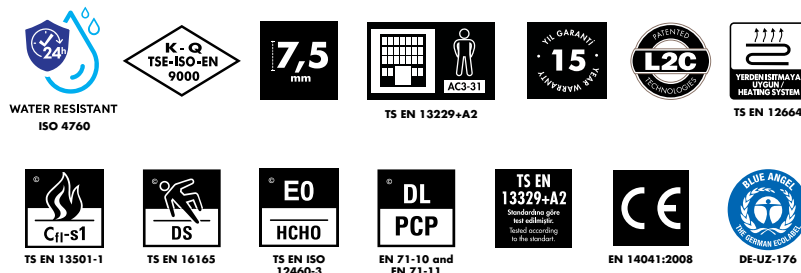



vega

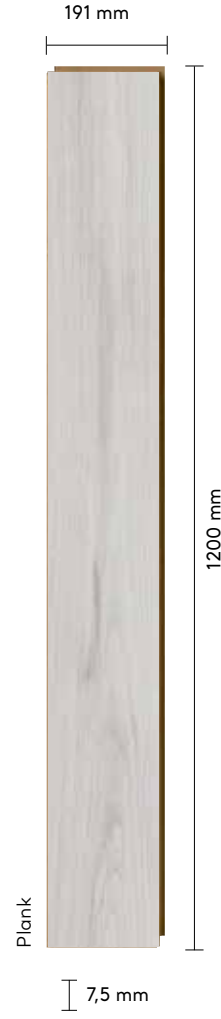

Vega ile evinizi yıldızların parıltısı ile aydınlatın. Yıldız ışığı Vega ile mekanınıza yumuşacık bir dokunuşla süzülerek iç dünyanıza huzur katın.

Illuminate your home with the twinkle of the stars with Vega. Add peace to your inner world by floating into your space with a soft touch with starlight Vega.





astera



Detaylara önem verenlerin, hem konforunu hem de şıklıklarını öncelikli kılanların tercihi. Her ayrıntıda zarafet ve rahatlığın uyum içinde olduğu Astera ile kişisel tarzınızı yansıtın.

It is the choice of those who pay attention to details and prioritize both comfort and elegance. Reflect your personal style with Astera, where elegance and comfort are in harmony in every detail.

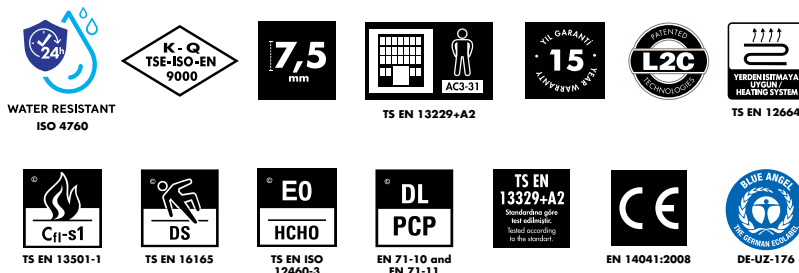



anita

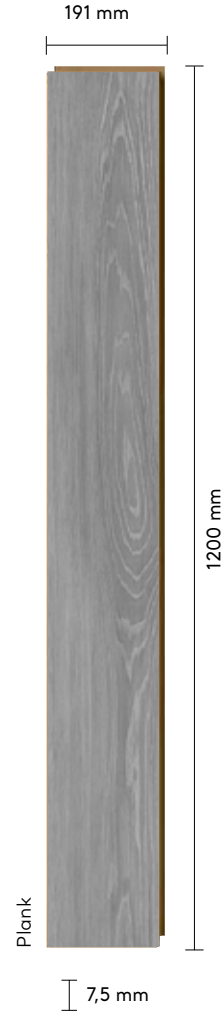

Anita'nın zarif tasarım anlayışı, mekanlarınıza estetik bir dokunuş katarken şıklıkla özgünlüğü buluşturur. Her detayda kendini gösteren incelik ile mekanınızı adeta bir sanat eseri haline getirin. Özgün tasarımlarının zarafeti ile ortama benzersiz bir atmosfer ve sıcaklık kazandırın.

Anita's elegant designs blend style and originality, adding beauty to your spaces. Transform your space into a masterpiece with the delicate details in every piece. Experience a unique and inviting atmosphere with Anita's original designs.

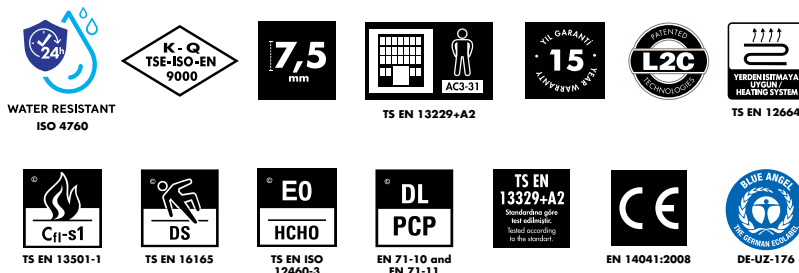



perle

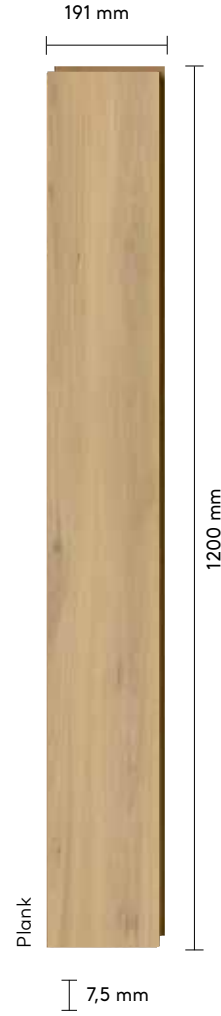

Kalitesiyle inci gibi parlayarak, estetik ve dayanıklılığın mükemmel uyumunu kusursuz bir şekilde yansıtır. Her detayıyla göz alıcı bir zarafeti temsil eden Perle ile yaşam alanlarınıza sadece bir nesne değil, aynı zamanda bir sanat eseri kazandırın.

Perle shines brightly with quality, reflecting a perfect blend of beauty and durability. With Perle, your living spaces become not just furnished, but transformed into works of art.





pigato



Yaşam alanınıza getirdiği çağdaş estetik ve benzersiz işlevsellik ile sıradanlığın ötesinde bir deneyim sunan Pigato ile her kullanımda pratik ve şık bir çözümü taşıyın.

Pigato brings practical style to every use, offering a unique experience with its contemporary look and special features for your living space.

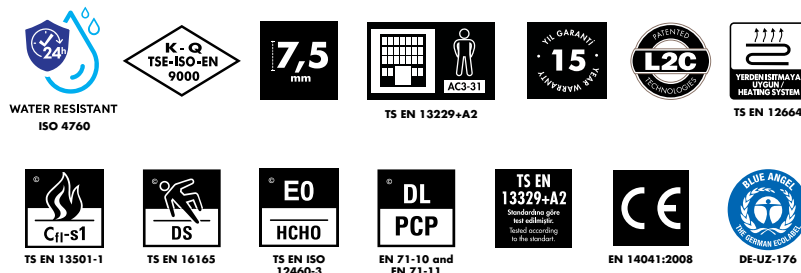

CORVINA TEKNİK ÖZELLİKLER CORVINA TECHNICAL SPECIFICATIONS

ÖZELLİKLER / SPECIFICATIONS	STANDART / STANDARD	SONUÇLAR / RESULTS
Elementler arası kalınlık farkı <i>Thickness difference between elements</i>	EN 13329	T ortalama < 0,50 mm t max-t min < 0,50 mm T average < 0,50 mm t max-t min < 0,50 mm
Elementin baş kısım gönye sapması <i>Deviation from squareness of element</i>	EN 13329	Q max < 0,2mm
Yüzey tabakasının uzunluğu <i>Length tolerance</i>	EN 13329	l < 1500mm l fark < 0,5mm l < 1500mm l difference < 0,5mm
Yüzey tabakasının genişliği <i>Width tolerance</i>	EN 13329	W ortalama fark 0,10mm w max- w min < 0,20mm W average difference 0,10mm w max- w min < 0,20mm
Kılıcına dönme miktarı <i>Edgewise bending</i>	EN 13329	0,30 mm
Elementin yüzey düzgünlüğü <i>Element's surface smoothness</i>	EN 13329	Fw içbükey < %0,15 fw dışbükey < %0,20 F1 içbükey < %0,50 fl dışbükey < %1,00 Fw concave < %0,15 fw convex < %0,20 F1 concave < %0,50 fl convex < %1,00
Elementler arası açıklık <i>Space between elements</i>	EN 13329	O ortalama < 0,15mm o en büyük 0,15mm O average < 0,15mm o max 0,15mm
Elementler arası yükseklik farkı <i>Height difference between elements</i>	EN 13329	H ortalama < 0,10mm H max < 0,15mm H average < 0,10mm H max < 0,15mm
Yüzey sağlamlığı <i>Surface soundness</i>	EN 13329	S > 1 N/mm ²
Işık haslılığı <i>Light fastness</i>	EN ISO 4892 - 2:200	EN 20105 - A02'ye göre gri ölçekte ≥ 4 maruz kalmayan ve maruz kalan örnek parça arasındaki renk kontrastı Colour contrast between unexposed and exposed sample part ≥ 4 of grey scale according to EN 20105 - A02
Çarpma mukavemeti <i>Impact resistance</i>	EN 13329	31. ve 32. sınıf için IC1 IC1 for 31th and 32th class
Koltuk tekerleği etkisi <i>Determination of the effect of a castor chair</i>	EN 425	Görünümde bir değişiklik veya zarar olmayacak No change or damage on appearance should occur
Mobilya ayağı etkisi <i>Determination of the effect of a castor furniture</i>	EN 424	Görülebilir zarar olmamalıdır. No visible damage should occur
Sıcak kaplara dayanıklılık <i>Resistance to hot pots</i>	EN 13329	Sınıf 4 / Class 4
Su buharına karşı dayanıklılık <i>Resistance to water vapor</i>	EN 13329	Sınıf 4 / Class 4
Leke tutmaya karşı dayanıklılık <i>Stain resistance</i>	EN 13329	Sınıf 5 / Class 5
24 saat suda şişme <i>24 hours swelling in thickness</i>	EN 13329	< %18
Yoğunluk <i>Density</i>	EN 323	AGT'ye özgü/Specific to AGT
Eğilme dayanımı <i>Bending strenght</i>	EN 317	850-900 kg/mm ³
Elastikiyet modülü <i>Modulus of elasticity</i>	EN 310	> 3500 N/mm ²
Çekme dayanımı <i>Vertical internal bond</i>	EN 319	> 1,2 N/mm ²

















































AŞINMA SINIFLARI/ABRASION CLASSES

	Az / Low			Yoğun / High		
CORVINA	21	22	23	31	32	33
	AC1	AC2	AC3	AC4	AC5	
Ortalama aşınma değeri / Average abrasion value	>2000					

AGT PARKE ÖZELLİKLERİ

AGT FLOORING FEATURES

SERİ FLOORING MODEL	BOYUT (mm) MEASUREMENT	AŞINMA SINIFI ABRASSION CLASS	KALINLIK (mm) THICKNESS	DERZ EDGE	YÜZEY SURFACE
CORVINA	191x1200	AC3-31	7,5	Yok	Oiled Oak
<i>Bella</i> ^{nbo}	191x1200	AC3-31	8	Yok	Viva Wood
Natura <small>SELECT</small>	191x1200	AC4-32	8	Yok	Natura
Luna	191x1200	AC3-31	8	Var	Viva Wood
<i>Natura</i> <small>Line</small>	191x1200	AC4-32	8	Var	Natura
Pruva	188x1200	AC4-32	8	Yok	Natura
ARMONIA <small>LARGE</small>	246x1380	AC4-32	8	Var	Baviera Wood
effect	191x1200	AC4-32	8	Var	Register
Yoga <small>COLLECTION</small>	191x1200	AC4-32	8	Var	Register
MARCOPOLO	191x1200	AC4-32	8	Var	Register
ARMONIA <small>SLIM</small>	159x1380	AC4-32	8	Var	Baviera Wood
CONCEPT <small>NEO</small>	154,5x1195	AC4-32	10	Var	Oiled Oak
effect <small>Premium</small>	189x1195	AC5-33	12	Var	Register
Yoga <small>COLLECTION</small>	189x1195	AC5-33	12	Var	Register
MARCOPOLO	189x1195	AC5-33	12	Var	Register
effect <small>Elegance</small>	154,5x1195	AC5-33	12	Var	Register
mood	325x1195	AC4-32	10	Var	Mood Surface

PAKET (m ²) PACKAGE	PALET (m ²) PALETTE	GARANTİ SÜRESİ WARRANTY (Year)	SERTİFİKALAR PRODUCT SPECIFICATIONS		
10x  =2,292 m ² =14,04 kg	52x  =119,184 m ²	15			
10x  =2,292 m ² =16,50 kg	48x  =110,016 m ²	15			
8x  =1,8336 m ² =13,20 kg	60x  =110,016 m ²	20			
10x  =2,292 m ² =16,50 kg	48x  =110,016 m ²	15			
8x  =1,8336 m ² =13,20 kg	60x  =110,016 m ²	20			
8x  =1,8048 m ² =12,90 kg	60x  =108,288 m ²	20			
7x  =2,3764 m ² =17,00 kg	52x  =123,570 m ²	20			
8x  =1,8336 m ² =13,20 kg	60x  =110,016 m ²	20			
8x  =1,8336 m ² =13,20 kg	60x  =110,016 m ²	20			 
8x  =1,8336 m ² =13,20 kg	60x  =110,016 m ²	20			
10x  =2,1942 m ² =15,70 kg	60x  =131,652 m ²	20			
8x  =1,4770 m ² =13,30 kg	60x  =88,621 m ²	20			
6x  =1,3551 m ² =14,60 kg	52x  =70,467 m ²	25			
6x  =1,3551 m ² =14,60 kg	52x  =70,467 m ²	25			 
6x  =1,3551 m ² =14,60 kg	52x  =70,467 m ²	25			 
6x  =1,1078 m ² =12,00 kg	60x  =66,466 m ²	25			
5x  =1,9418 m ² =17,50 kg	54x  =104,860 m ²	20			 



AGT SÜPÜRGELİK KOLEKSİYONLARI İLE KUSURSUZ MEKANLAR

AGT Süpürgelikler, tüm AGT ürünleri ile mükemmel uyum sağlar.
Geniş dekor ve model seçenekleri arasından size en uygun
olanı seçin, mekanınıza yenilik katın.

PERFECT SPACES WITH AGT SKIRTING SERIES

*AGT Skirtings perfectly fit with all AGT products.
Choose the one that suits you best from a wide range
decor and model options and add innovation to your space.*



SÜPÜRGELİK PROFİLLERİ

SKIRTING PROFILES

Yeni
New

SPR-8102

12x78x2800 mm

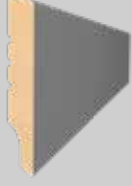

Yeni
New

SPR-8100

12x96x2800 mm



Yeni
New

SPR-8103

12x96x2800 mm



Yeni
New

SPR-8105

9x101x2800 mm

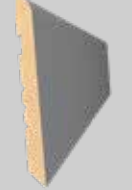

SPR-9011

12x100x2800 mm



SPR-9010

12x80x2800 mm

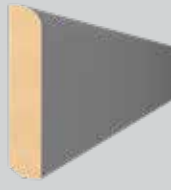

SPR-9007

12x80x2800 mm



SPR-9028

12x80x2800 mm



SPR-9029

12x100x2800 mm



SPR-6050

12x22x2800 mm



SPR-5030

9x60x2800 mm



SPR-5000-E

9x79x2800 mm



SPR-7034

9x80x2800 mm



SPR-7063

9x80x2800 mm



SPR-7007

16x80x2800 mm



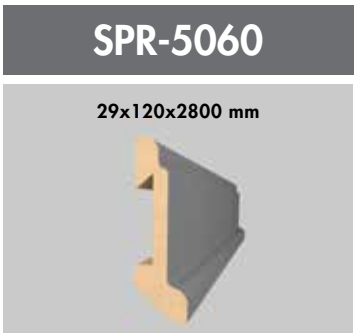
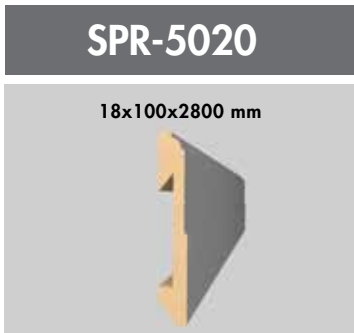
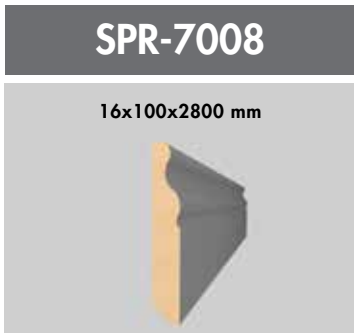
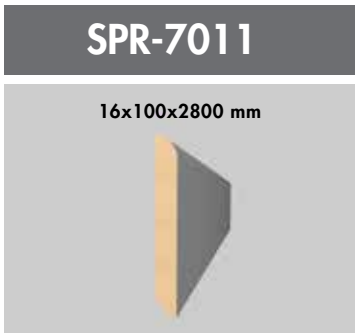
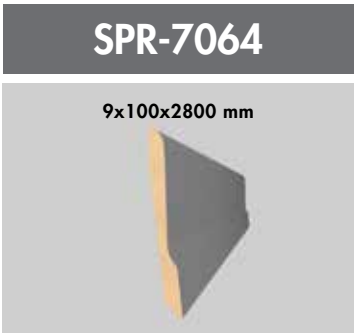
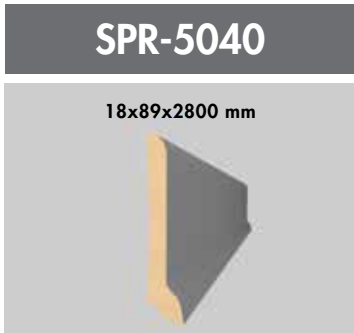
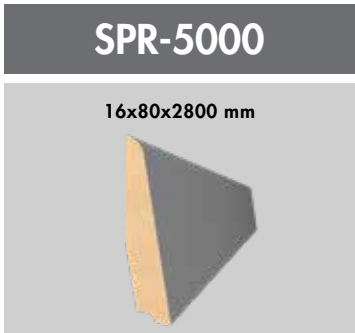
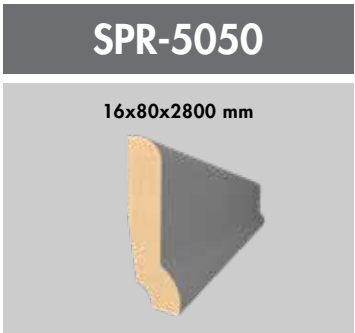
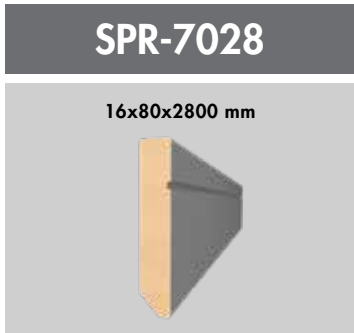
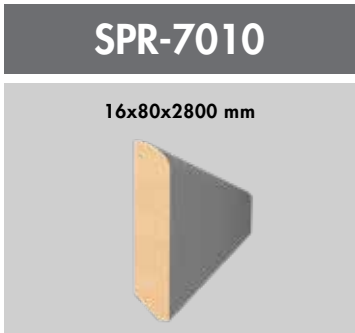

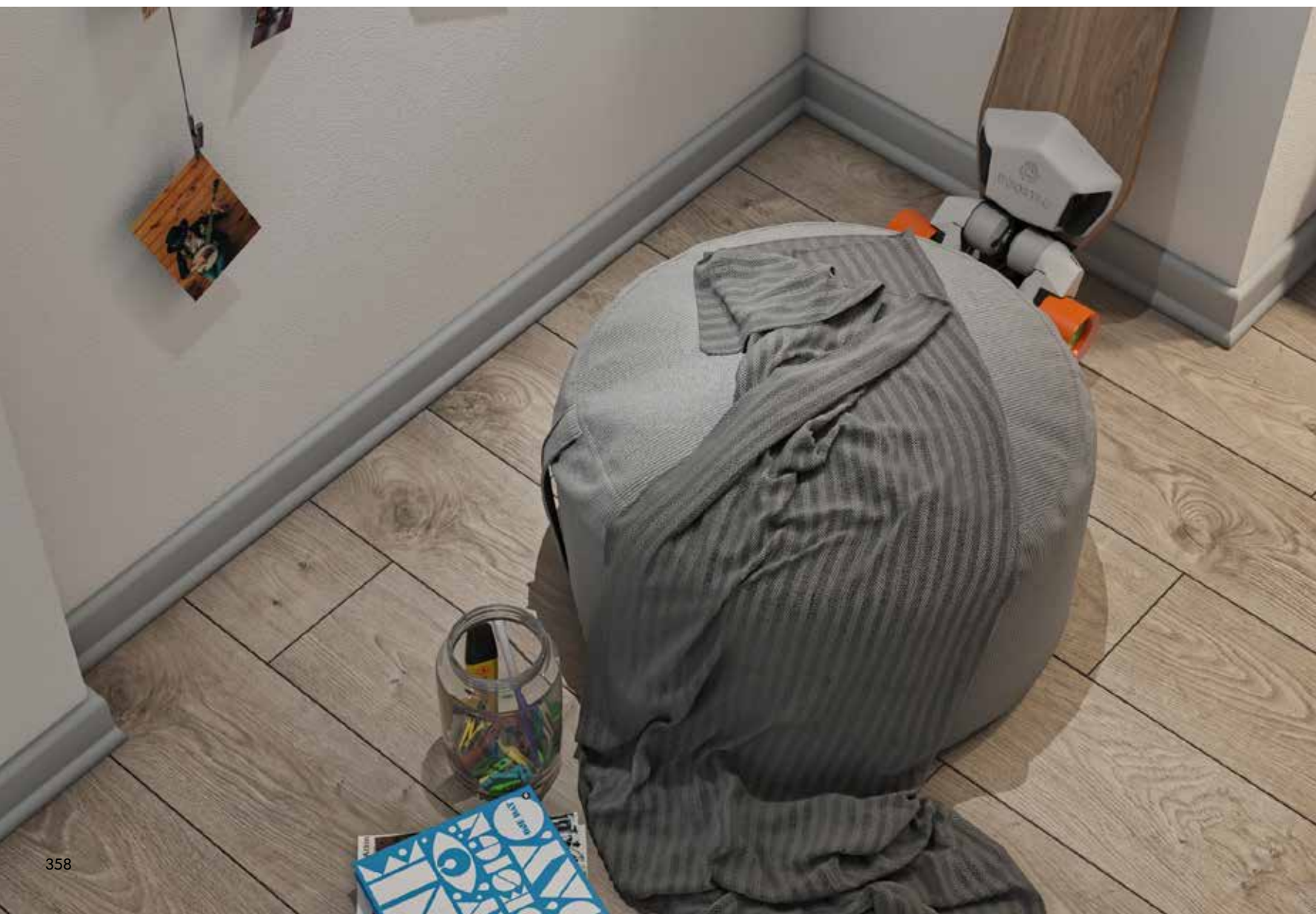

SÜPÜRGELİK DEKORLAR

SKIRTING DECORS

Beyaz (Boyanabilir) / White (Paintable)



231 Bute Beyaz/
Plain White

1.Grup / 1.Group



3072 Lake Beyaz/
Lacquer White



3067 Lake Gri/
Lacquer Grey



3068 Lake Antrasit/
Lacquer Anthracite

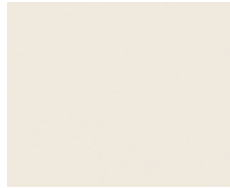

366 Bianco



369 Alman Meşe/
German Oak



248 Tik/Teak

2.Grup / 2.Group



734 Soft Touch
Beyaz/Soft Touch
White



729 Soft Touch
Yeni Gri/Soft Touch
New Grey



728 Soft Touch
Kaya Gri/Soft
Touch Stone Grey



726 Soft Touch
Fırtına Gri/
Soft Touch Storm
Grey

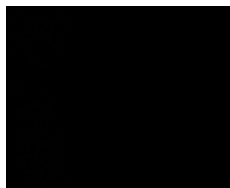



723 Soft Touch
Siyah/Soft Touch
Black



608 HG Metalik
Antrasit/HG Metallic
Anthracite

AGT SÜPÜRGELİK KARKAS MODELLERİ

AGT SKIRTING CARCASS MODELS

KOD NUMARASI/ CODE NUMBER	ÖLÇÜ (mm)/ MEASUREMENT (mm)	ÜRÜN KESİTİ/ CROSS-SECTION	UYUMLU SÜPÜRGELİKLER/ AVAILABLE SKIRTINGS
SK-2001	10x43x2800		SPR-5070
SK-2000	10x51x2800		SPR-5020 / SPR-5060



AGT

WOOD
MEETS
TECHNOLOGY